

Compact cylinders ADN/AEN, to ISO 21287

FESTO



Festo core product range
Covers 80% of your automation tasks

Worldwide:
Superb:
Easy:

Always in stock
Festo quality at an attractive price
Reduces procurement and storing complexity

★ Generally ready for shipping ex works in 24 hours
Held in stock in 13 service centres worldwide
More than 2200 product
★ Generally ready for shipping ex works in 5 days
Assembled for you in 4 service centres worldwide
Up to 6 x 10¹² variants per product series

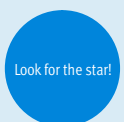

Compact cylinders ADN/AEN, to ISO 21287

Key features



At a glance

Sensor slots on three sides for flush mounting of proximity sensors

Piston rod with choice of male or female thread

Mounting option: Female thread and through-hole

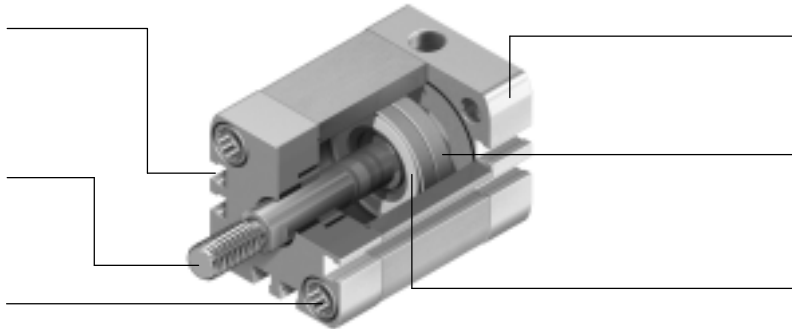

Centring hole in the end cap matches centring pins ZBS

Magnet for contactless position sensing

Integrated cushioning for absorbing residual energy

More than the standard

- The compact cylinder series ADN/AEN complies with the standard ISO 21287
- The ADN/AEN is distinguished by its compact design and broad area of application thanks to the large number of variants
- The variants can be configured according to individual needs thanks to the modular product system

Powerful

- Integrated cushioning for absorbing residual energy
- Long service life thanks to exceptional cushioning characteristics and minimal friction factors

Convenient

- Easy to mount with a comprehensive range of mounting accessories for just about every type of installation
- Highly flexible thanks to the wide range of variants
- Contactless position sensing using proximity sensors

Reliable

- Optimised manufacturing methods, patented technology and more than 40 years of experience in the field of cylinders make Festo and ADN/AEN a great team

Mounting options

With through screw

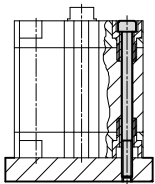

Direct mounting

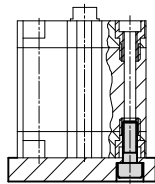

Size comparison between ISO 21287 and ISO 15552

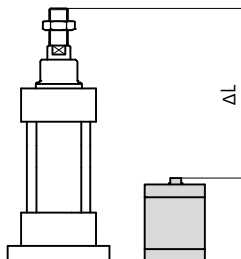

- Space savings of up to 50% compared with the standard ISO 15552

Cushioning types

Cushioning P

Mode of operation

- The drive is equipped with polymer flexible end-position cushioning

Application

- Small loads
- Low speeds
- Small cushioning capacity

Advantages

- No adjustment required
- Time-saving

Cushioning PPS

Mode of operation

- The drive is equipped with self-adjusting, pneumatic end-position cushioning

Application

- Larger loads
- Higher speeds
- Larger cushioning capacity

Advantages

- No adjustment required
- Up to four times greater cushioning capacity than ADN-...-P
- Time-saving
- Noise reduction





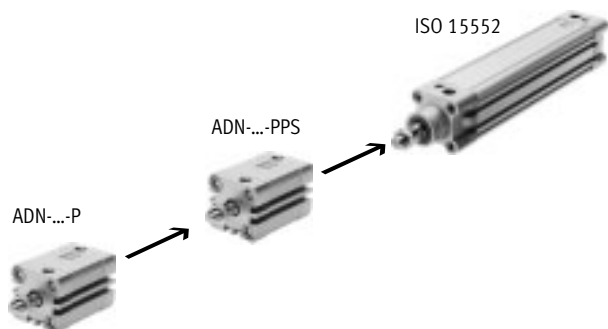







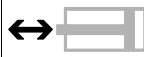

Cushioning capacity of ISO 21287 and ISO 15552

In terms of cushioning capacity, the compact cylinder ADN-...-PPS fills the gap between ADN-...-P and standard cylinders with ISO 15552.

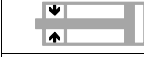
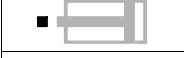

Compact cylinders ADN, to ISO 21287

Key features

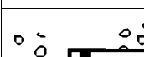



Variants from the modular product system		
Symbol	Key features	Description
	S1 Reinforced piston rod	Increased lateral forces. Absorbs many times more lateral force than a basic cylinder
	S2 Through piston rod	For working at both ends with the same force in the forward and return stroke, for attaching external stops
	S6 Heat-resistant seals	Temperature resistance up to max. 120 °C
	S10 Constant motion (slow speed) at low piston speeds	Suitable for slow stroke movements at a constant, judder-free speed over the full stroke of the cylinder. Seal contains silicone grease (not free of paint-wetting impairment substances)
	S11 Low friction	The special seals considerably reduce system wear. This corresponds to a considerably lower response pressure. Seal contains silicone grease (not free of paint-wetting impairment substances)
	S20 Through, hollow piston rod	For supplying vacuum, small parts, media, etc.
	K2 Extended male piston rod thread	–
	K5 Special piston rod thread	Metric standard thread to ISO
	K8 Extended piston rod	–
	K10 Smooth anodised aluminium piston rod	Ideal for use in welding environments: – Protection against welding spatter – Small working loads – Harder surface compared to steel – Long service life
	KP With clamping unit	Integrated clamping unit on the piston rod
	EL With end-position locking	Positive locking in the end position as a drop guard. If there is a drop in pressure, the piston rod is secured in its end position to prevent it from dropping
	Q Square piston rod	Protection against rotation. For correctly oriented feeding
	R3 High corrosion protection	All external cylinder surfaces comply with corrosion resistance class 3 to Festo standard 940 070. The piston rod is made from corrosion and acid resistant steel
	R8 Dust protection (wiper seal)	The cylinder is equipped with a hard-chrome plated piston rod and a rigid wiper seal, which protects against dry, dusty media
	TL Captive rating plate	Laser etched rating plate. For easy identification of components when it comes to replacement, even after years in a harsh environment
	TT Low temperature	Temperature resistance down to max. –40 °C

Software tools and configuration of Festo modular products
[→www.festo.com](http://www.festo.com)

Compact cylinders ADN, to ISO 21287

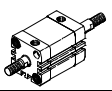
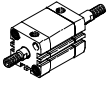
Product range overview

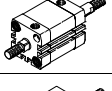
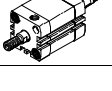

Function	Version	Type	Piston \varnothing	Stroke	Position sensing	Cushioning		
			[mm]			[mm]	A	P
Double-acting	Basic version							
		ADN	12	5, 10, 15, 20, 25, 30, 40	1 ... 300	■	■	■ ∅ 20 ... 100
			16	5, 10, 15, 20, 25, 30, 40, 50	1 ... 300			
			20, 25	5, 10, 15, 20, 25, 30, 40, 50, 60	1 ... 300			
			32, 40, 50	5, 10, 15, 20, 25, 30, 40, 50, 60, 80	1 ... 400			
			63	10, 15, 20, 25, 30, 40, 50, 60, 80	1 ... 400			
			80, 100	10, 15, 20, 25, 30, 40, 50, 60, 80	1 ... 500			
			125	-	1 ... 500			
		ADN-...-S2 Through piston rod	12, 16, 20, 25	-	1 ... 300	■	■	■ ∅ 20 ... 100
			32, 40, 50, 63	-	1 ... 400			
			80, 100, 125	-	1 ... 500			
		ADN-...-S20 Through, hollow piston rod	16, 20, 25	-	1 ... 300	■	■	■ ∅ 20 ... 100
			32, 40, 50, 63	-	1 ... 400			
			80, 100, 125	-	1 ... 500			
	Reinforced piston rod							
		ADN-...-S1	25	-	5 ... 300	■	■	-
			40, 63	-	10 ... 400			
			100	-	10 ... 500			
	Non-rotating with square piston rod							
		ADN-...-Q	12, 16, 20, 25	-	1 ... 300	■	■	-
			32, 40, 50, 63	-	1 ... 400			
			80, 100, 125	-	1 ... 500			
		ADN-...-Q-S2 Through piston rod	12, 16, 20, 25	-	1 ... 300	■	■	-
			32, 40, 50, 63	-	1 ... 400			
			80, 100, 125	-	1 ... 500			
		ADN-...-Q-S20 Through, hollow piston rod	16, 20, 25	-	1 ... 200	■	■	-
			32, 40, 50, 63	-	1 ... 300			
			80, 100, 125	-	1 ... 400			
Standard hole pattern, with clamping unit								
	ADN-...-KP	20, 25	-	10 ... 300	■	■	-	
		32, 40, 50, 63	-	10 ... 400				
		80, 100	-	10 ... 500				
Standard hole pattern, with end-position locking								
	ADN-...-EL	20, 25	-	10 ... 300	■	■	-	
		32, 40, 50, 63	-	10 ... 400				
		80, 100	-	10 ... 500				

Compact cylinders ADN, to ISO 21287

Product range overview

Type	Male piston rod thread	Female piston rod thread	Extended male piston rod thread	Special piston rod thread	Extended piston rod	Smooth anodised piston rod	Heat-resistant seals max. 120 °C	Slow speed (constant motion)	Low friction	High corrosion protection	Dust protection	Low temperature	→ Page/Internet
	A	I	K2	K5	K8	K10	S6	S10	S11	R3	R8	TT	
Basic version													
ADN	■	■	■	■	■	■ ∅ 20 and above	■	■	■	■	■ ∅ 20 and above	■ ∅ 20 ... 100	13
ADN...-S2 Through piston rod	■	■	■	■	■	-	■	-	-	-	-	■ ∅ 20 ... 100	13
ADN...-S20 Through, hollow piston rod	■	-	■	■	■	-	■	-	-	-	-	-	13
Reinforced piston rod													
ADN...-S1	■	■	■	■	■	-	■	-	-	■	-	-	13
Non-rotating with square piston rod													
ADN...-Q	■	■	■	■	■	-	■	-	-	-	-	-	13
ADN...-Q-S2 Through piston rod	■	■	■	■	■	-	■	-	-	-	-	-	13
ADN...-Q-S20 Through, hollow piston rod	■	-	■	■	■	-	■	-	-	-	-	-	13
Standard hole pattern, with clamping unit													
ADN...-KP	■	■	■	■	■	-	-	-	-	-	-	-	40
Standard hole pattern, with end-position locking													
ADN...-EL	■	■	■	■	■	-	-	-	-	-	-	-	49

Compact cylinders ADN, to ISO 21287

Product range overview



Function	Version	Type	Piston \varnothing	Stroke	Position sensing	Cushioning		
			[mm]			[mm]	A	P
Double-acting	Standard hole pattern, non-rotating with yoke							
		ADNGF	12	5, 10, 15, 20, 25, 30, 40	1 ... 200	■	■	■ \varnothing 20 ... 100
			16	5, 10, 15, 20, 25, 30, 40, 50	1 ... 200			
			20, 25	5, 10, 15, 20, 25, 30, 40, 50, 60	3 ... 200			
			32, 40, 50	5, 10, 15, 20, 25, 30, 40, 50, 60, 80	5 ... 300			
			63, 80	10, 15, 20, 25, 30, 40, 50, 60, 80	5 ... 300			
		ADNGF-...-S2 Through piston rod	12, 16	–	1 ... 200	■	■	■ \varnothing 20 ... 100
			20, 25		3 ... 200			
			32, 40, 50, 63, 80, 100		5 ... 250			
	Standard hole pattern, high-force cylinder							
		ADNH	25	–	1 ... 150	■	■	–
			40					
			63					
			100					
Standard hole pattern, multi-position cylinder								
	ADNM	25	–	1 ... 2,000	■	■	–	
		40						
		63						
		100						

Compact cylinders ADN, to ISO 21287



Product range overview

Type	Male piston rod thread	Female piston rod thread	Extended male piston rod thread	Special piston rod thread	Extended piston rod	Heat-resistant seals max. 120 °C	→ Page/Internet
	A	I	K2	K5	K8	S6	
Standard hole pattern, non-rotating with yoke							
ADNGF	-	-	-	-	-	■	adngf
ADNGF-...-S2 Through piston rod	-	-	-	-	-	■	adngf
Standard hole pattern, high-force cylinder							
ADNH	■	■	■	■	■	■	adnh
Standard hole pattern, multi-position cylinder							
ADNM	■	■	■	■	■	■	adnh

Compact cylinders AEN, to ISO 21287

Product overview

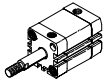

Function	Version	Type	Piston \varnothing	Stroke	Position sensing	Cushioning
			[mm]	[mm]	A	P
Single-acting	Basic version					
		AEN	12	1 ... 10	■	■
			16, 20, 25, 32, 40, 50, 63, 80, 100	1 ... 25		
		AEN-...-Z pulling	12	1 ... 10	■	■
			16, 20, 25, 32, 40, 50, 63, 80, 100	1 ... 25		
	Non-rotating with square piston rod					
	AEN-...-Q	16	1 ... 25	■	■	
		20, 25, 32, 40, 50, 63, 80, 100	1 ... 25			

Compact cylinders AEN, to ISO 21287

Product overview

Type	Male piston rod thread	Female piston rod thread	Extended male piston rod thread	Special piston rod thread	Extended piston rod	Smooth anodised piston rod	Heat-resistant seals up to max. 120 °C	→ Page/Internet
	A	I	K2	K5	K8	K10	S6	
Basic version								
AEN	■	■	■	■	■	■ ∅ 20 and above	■	59
AEN-...-Z pulling	■	■	■	■	■	■ ∅ 20 and above	■	59
Non-rotating with square piston rod								
AEN-...-Q	■	■	■	■	■	-	■	59

Compact cylinders ADN/AEN, to ISO 21287

Peripherals overview

FESTO

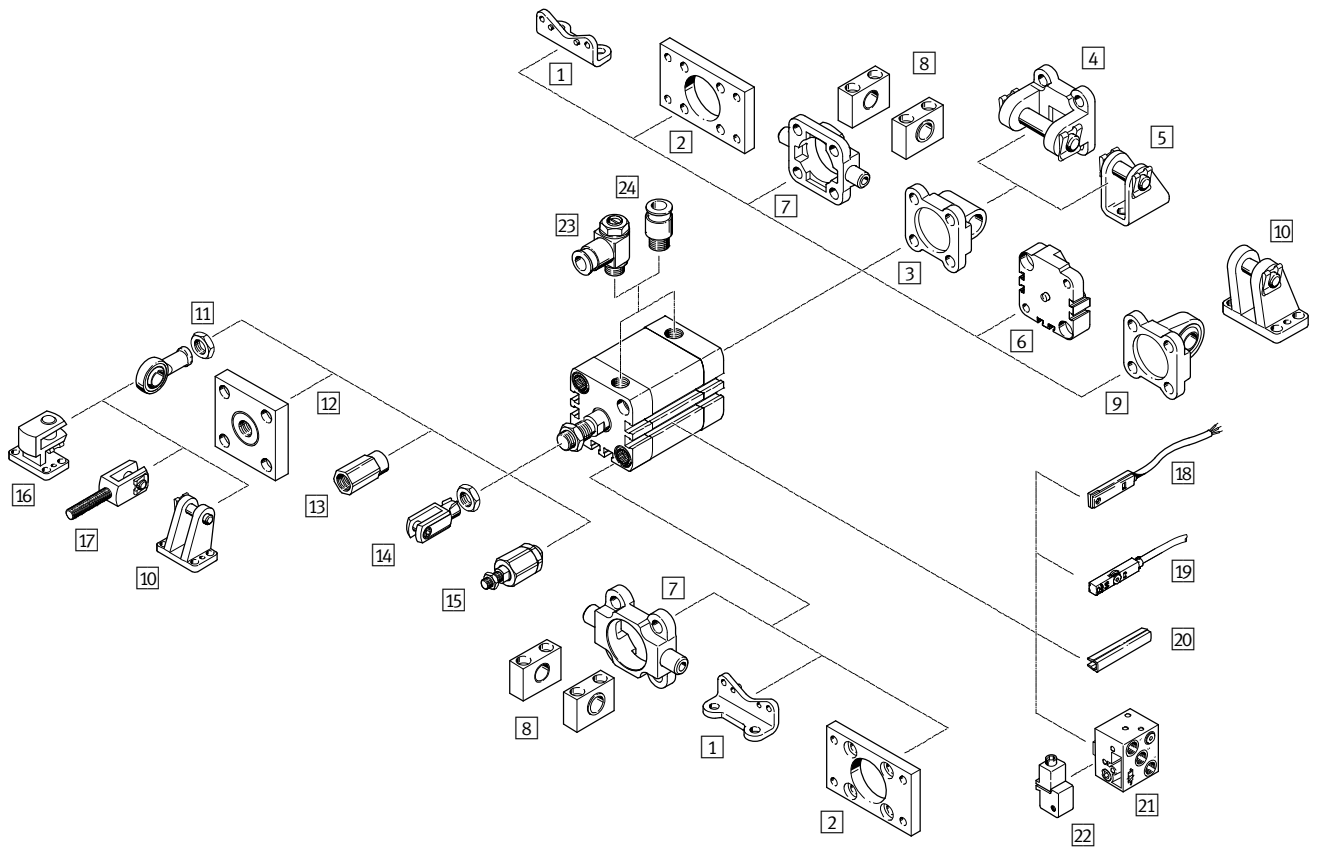

Compact cylinders ADN/AEN, to ISO 21287

Peripherals overview

FESTO

Mounting attachments and accessories		
	Description	→ Page/Internet
1	Foot mounting HNA	For bearing or end caps 72
2	Flange mounting FNC	For bearing or end caps 73
3	Swivel flange SNCL/SNCL-...-R3	For end caps 74
4	Swivel flange SNCB/SNCB-...-R3	For swivel flange SNCL 79
5	Clevis foot LBN/CRLBN	For swivel flange SNCL 78
6	Multi-position kit DPNA	For connecting two cylinders with identical piston \varnothing to form a multi-position cylinder 77
7	Trunnion flange ZNCF/CRZNG	For bearing caps 80
8	Trunnion support LNZG	For trunnion flange ZNCF/CRZNG 81
9	Swivel flange SNCS/CRSNCS/SNCS-...-R3	For end caps 75
10	Clevis foot LBG/LBG-...-R3	For swivel flange SNCS 76
11	Rod eye SGS/CRSGS	With spherical bearing 82
12	Coupling piece KSG/KSZ	For compensating radial deviations 82
13	Adapter AD	For mounting a vacuum suction cup on a hollow cylinder piston rod 82
14	Rod clevis SG/CRSG	Permits a swivelling movement of the cylinder in one plane 82
15	Self-aligning rod coupler FK/CRFK	For compensating radial and angular deviations 82
16	Right-angle clevis foot LQG	For rod eye SGS 83
17	Rod clevis SGA	With male thread 82
18	Proximity sensor SME/SMT-8	Can be integrated in the sensor slot of the cylinder profile barrel 85
19	Proximity sensor SME/SMT-8M	Can be integrated in the sensor slot of the cylinder profile barrel 85
20	Slot cover ABP-5-S	For protecting the sensor cable and keeping dirt out of the sensor slots 85
21	Proximity sensor SMPO-8E	Pneumatic output signal 85
22	Mounting kit SMB-8E	For proximity sensor SMPO-8E 85
23	One-way flow control valve GRLA/GRLZ	For speed regulation 83
24	Push-in fitting QS	For connecting compressed air tubing with standard external diameters qs

Compact cylinders ADN, to ISO 21287

Type codes

FESTO

ADN – 50 – 50 – A – P – A – S2

Type

Double-acting	
ADN	Compact cylinder

Piston Ø [mm]

Stroke [mm]

Piston rod thread

A	Male thread
I	Female thread

Cushioning

P	Flexible cushioning rings/pads at both ends
PPS	Pneumatic cushioning, self-adjusting at both ends

Position sensing

A	Via proximity sensor
---	----------------------

Variant

Q	Square piston rod
S1	Reinforced piston rod
S2	Through piston rod
S20	Through, hollow piston rod
K2	Piston rod with extended male thread
K5	Piston rod with special thread
K8	Extended piston rod
K10	Smooth anodised piston rod
S6	Heat-resistant seals up to max. 120 °C
S10	Slow speed (constant motion)
S11	Low friction
R3	High corrosion protection
R8	Dust protection
TL	Captive rating plate
TT	Low temperature

Compact cylinders ADN, to ISO 21287

Technical data

Function
P cushioning

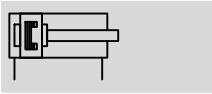

PPS cushioning

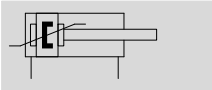

Variants → page 3

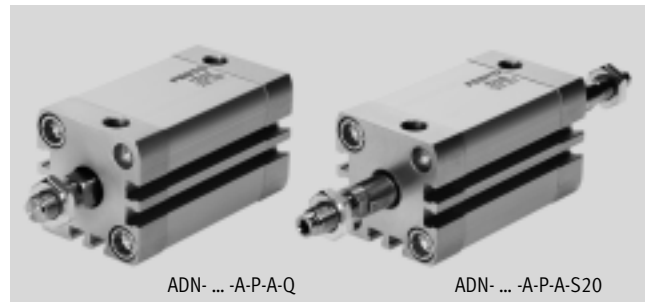
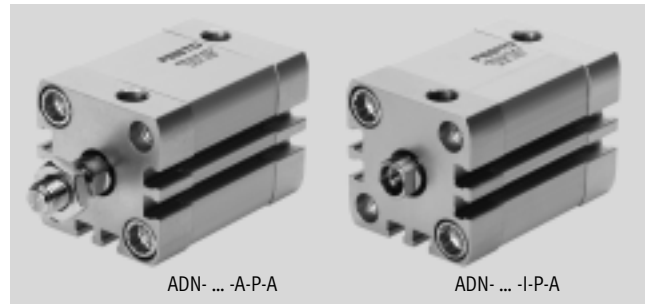

⌀ - Diameter
12 ... 125 mm

- | - Stroke length
1 ... 500 mm

- www.festo.com

General technical data											
Piston ⌀	12	16	20	25	32	40	50	63	80	100	125
Design	Piston										
	Piston rod										
	Cylinder barrel										
Mode of operation	Double-acting										
Cushioning											
P	Flexible cushioning rings/pads at both ends										
PPS	Pneumatic cushioning, self-adjusting at both ends										-
Cushioning length											
PPS	[mm]	-	3	3.5	4	5	6	7	7.5	10	-
Position sensing	Via proximity sensor										
Type of mounting	Via through-hole										
	Via female thread										
	Via accessories										
Mounting position	Any										

Technical data – Basic version and variants						
Piston ⌀	12	16	20	25	32	40
Pneumatic connection						
-	M5	M5	M5	M5	G1/8	G1/8
S1	-	-	-	M5	-	M5
Female piston rod thread						
-	M3	M4	M6	M6	M8	M8
K5	-	-	M5	M5	M6	M6
S1	-	-	-	M6	-	M10
S1-K5	-	-	-	M5	-	M8
Male piston rod thread						
-	M5	M6	M8	M8	M10x1.25	M10x1.25
K5	M6	M8	M10, M10x1.25	M10, M10x1.25	M10, M12	M10, M12
S1	-	-	-	M8	-	M12x1.25
S1-K5	-	-	-	M10, M10x1.25	-	M10x1.25, M12
Q-K5	M6	M8	M10; M10x1.25	M10; M10x1.25	M10	M10
Max. torsional backlash of piston rod [°]						
Q	2	1.8	1.6	1.6	1.2	1.2

Compact cylinders ADN, to ISO 21287



Technical data

Technical data – Basic version and variants					
Piston Ø	50	63	80	100	125
Pneumatic connection					
–	G1/8	G1/8	G1/8	G1/8	G1/4
S1	–	G $\frac{1}{8}$	–	G $\frac{1}{8}$	–
Female piston rod thread					
–	M10	M10	M12	M12	M16
K5	M8	M8	M10	M10	–
S1	–	M12	–	M16	–
S1-K5	–	M10	–	–	–
Male piston rod thread					
–	M12x1.25	M12x1.25	M16x1.5	M16x1.5	M20x1.5
K5	M12, M16	M12, M16	M16, M20, M20x1.5	M16, M20, M20x1.5	M20
S1	–	M16x1.5	–	M20x1.5	–
S1-K5	–	M12x1.25, M16	–	M16x1.5, M20	–
Q-K5	M12	M12	M16	M16	M20
Max. torsional backlash of piston rod [°]					
Q	1	1	0.8	0.8	0.8

Operating and environmental conditions												
Piston Ø	12	16	20	25	32	40	50	63	80	100	125	
Operating medium	Compressed air in accordance with ISO 8573-1:2010 [7:4:4]											
Note on operating/pilot medium	Operation with lubricated medium possible (in which case lubricated operation will always be required)											
Operating pressure [bar]												
–	1 ... 10		0.6 ... 10									
PPS	–		1.5 ... 10			1 ... 10			–			
Q	1.3 ... 10		1 ... 10		0.8 ... 10			0.6 ... 10				
S1	–		1 ... 10		–		1 ... 10		–		1 ... 10	–
S2, S20	1.5 ... 10	1.3 ... 10	1.2 ... 10		1 ... 10			0.8 ... 10				
S6	1 ... 10		0.6 ... 10									
S11	0.45 ... 10				0.25 ... 10							
R8, TT	–		1.5 ... 10			1 ... 10			–			
Ambient temperature ¹⁾ [°C]												
–	–20 ... +80											
S6	0 ... +120											
R3	–20 ... +80											
TT	–		–40 ... +80							–		
Corrosion resistance class CRC ²⁾												
–	2											
R3	3											
ATEX	Specified types → www.festo.com											

1) Note operating range of proximity sensors

2) Corrosion resistance class CRC 2 to Festo standard FN 940070

Moderate corrosion stress. Indoor applications in which condensation may occur. External visible parts with primarily decorative requirements for the surface and which are in direct contact with the ambient atmosphere typical for industrial applications.

Corrosion resistance class CRC 3 to Festo standard FN 940070

High corrosion stress. Outdoor exposure under moderate corrosive conditions. External visible parts with primarily functional requirements for the surface and which are in direct contact with a normal industrial environment.

Compact cylinders ADN, to ISO 21287

Technical data

FESTO

Forces [N] and impact energy [J]											
Piston Ø	12	16	20	25	32	40	50	63	80	100	125
Theoretical force at 6 bar, advancing											
–	68	121	188	295	483	754	1178	1870	3016	4712	7363
S1	–	–	–	295	–	754	–	1870	–	4712	–
S2	51	90	141	247	415	686	1057	1750	2827	4524	7069
Theoretical force at 6 bar, retracting											
–	51	90	141	247	415	686	1057	1750	2827	4524	7069
S1	–	–	–	247	–	633	–	1681	–	4417	–
S2	51	90	141	247	415	686	1057	1750	2827	4524	7069
Max. impact energy in the end positions											
–	0.07	0.15	0.2	0.3	0.4	0.7	1	1.3	1.8	2.5	3.3
S1	–	–	–	0.3	–	0.7	–	1.3	–	2.5	–
S6	0.035	0.075	0.1	0.15	0.2	0.35	0.5	0.65	0.9	1.25	1.75
K10	–	–	0.16	0.24	0.32	0.56	0.8	1	1.4	2	2.6
S20	–	0.016	0.024	0.083	0.15	0.39	0.48	0.62	0.8	0.9	0.95

 Note
This data represents the maximum values that can be achieved. The maximum permissible impact energy must be observed.

Permissible impact velocity:
$$v_{perm.} = \sqrt{\frac{2 \times E_{perm.}}{m_{dead} + m_{load}}}$$

Maximum permissible load:
$$m_{load} = \frac{2 \times E_{perm.}}{v^2} - m_{dead}$$

$v_{perm.}$ Permissible impact velocity
 $E_{perm.}$ Max. impact energy
 m_{dead} Moving load (drive)
 m_{load} Moving effective load

 Note
In combination with PPS cushioning, the maximum impact energy is still obtained.

Max. energy conversion capacity [J]								
Piston Ø	20	25	32	40	50	63	80	100
For PPS cushioning	0.65	0.8	1	1.7	2.8	4.8	8	12

Max. lateral force F_q as a function of the projection x

Ø 12 ... 63

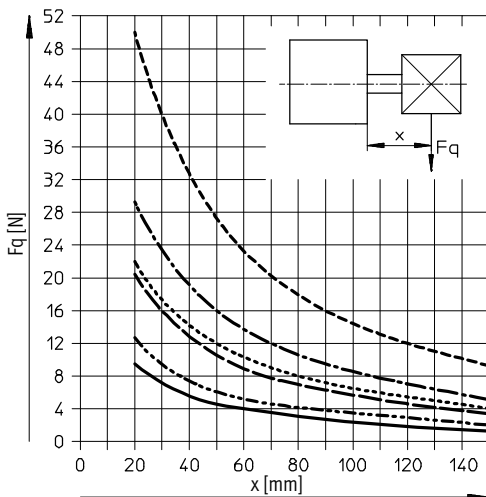

- Ø 12
- - - - - Ø 16
- · — · — Ø 20
- · · · · Ø 25
- · — · — Ø 32/40
- - - - - Ø 50/63

Ø 80 ... 125

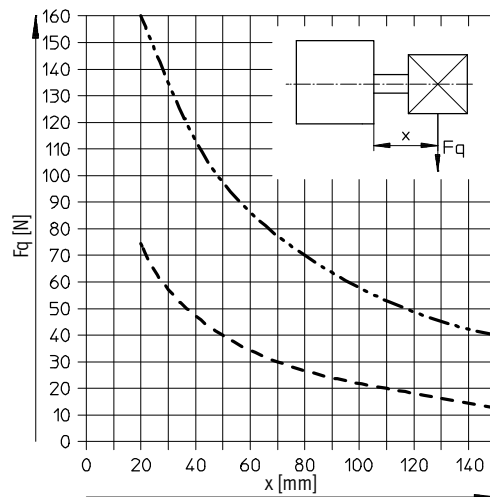

- - - - - Ø 80/100
- · · · · Ø 125

Compact cylinders ADN, to ISO 21287

Technical data

FESTO

Max. lateral force F_q as a function of the projection x and the lever arm a

Q – Square piston rod

Ø 12

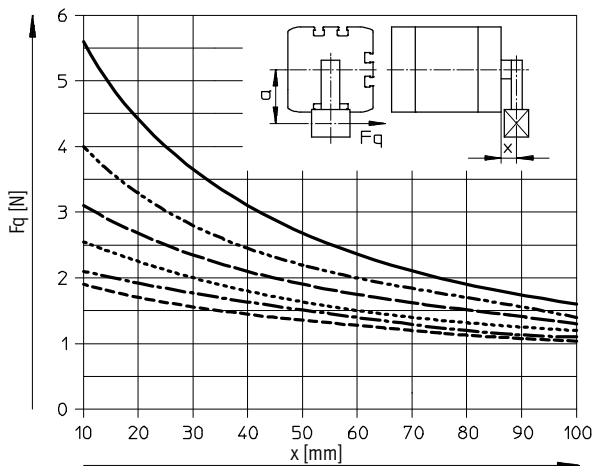

- a = 5 mm
- - - a = 10 mm
- - - a = 15 mm
- · - a = 20 mm
- · - a = 25 mm
- · - a = 30 mm

Ø 16

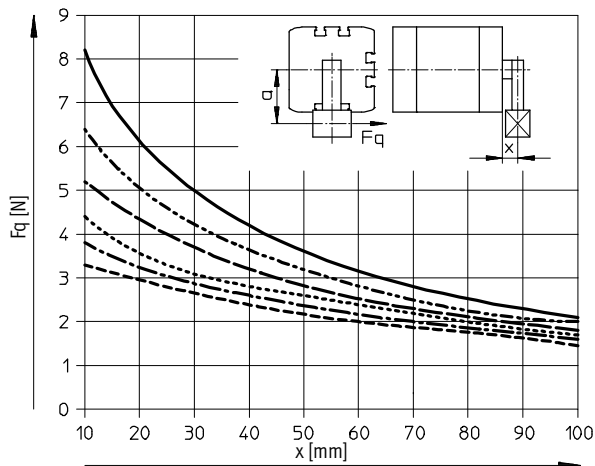

- a = 5 mm
- - - a = 10 mm
- - - a = 15 mm
- · - a = 20 mm
- · - a = 25 mm
- · - a = 30 mm

Ø 20/25

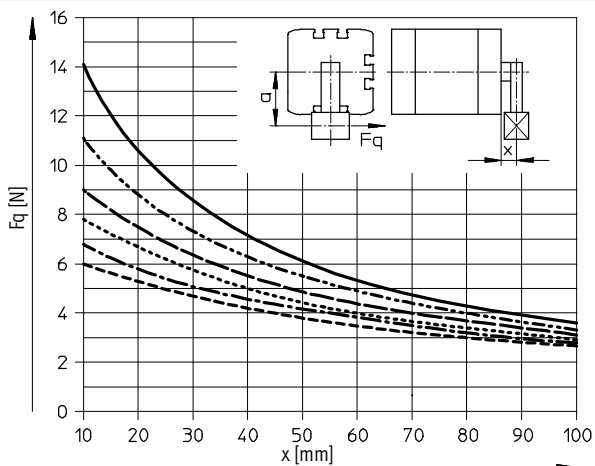

- a = 5 mm
- - - a = 10 mm
- - - a = 15 mm
- · - a = 20 mm
- · - a = 25 mm
- · - a = 30 mm

Ø 32/40

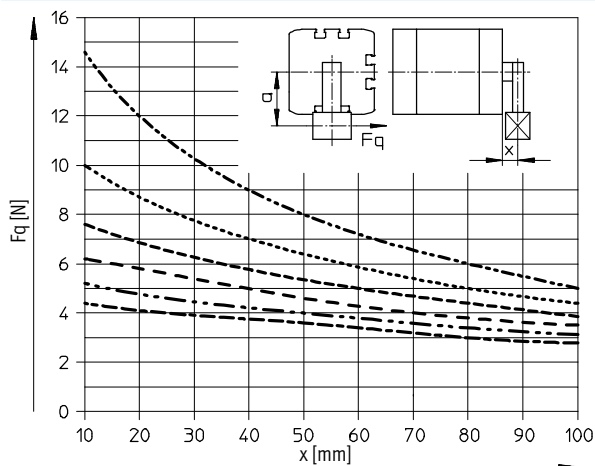

- · - a = 10 mm
- · - a = 20 mm
- - - a = 30 mm
- - - a = 40 mm
- · - a = 50 mm
- · - a = 60 mm

Note

• Torques on the piston rod are to be excluded with projections greater than those shown in the graphs.

• If $a = 0$, the corresponding lateral load line of the basic ADN version can be used (→ page 15).

Compact cylinders ADN, to ISO 21287

Technical data

FESTO

Max. lateral force F_q as a function of the projection x and the lever arm a

Q – Square piston rod

Ø 50/63

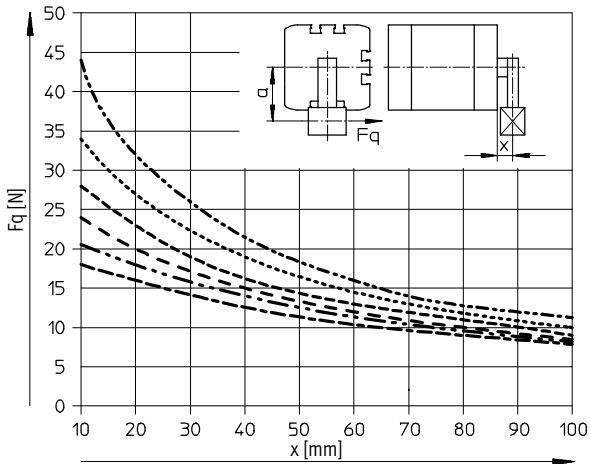

- a = 10 mm
- a = 20 mm
- a = 30 mm
- a = 40 mm
- a = 50 mm
- a = 60 mm

Ø 80/100

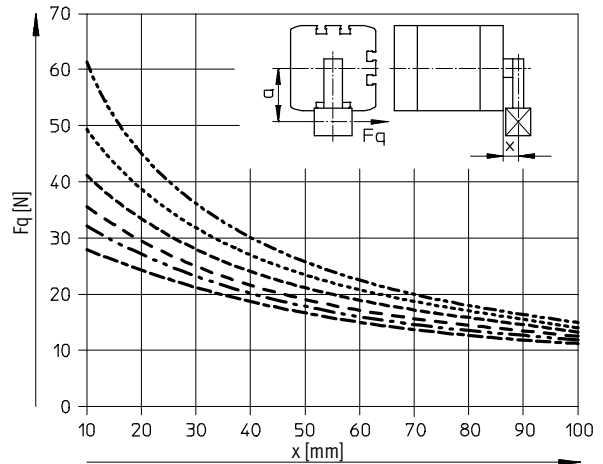

- a = 10 mm
- a = 20 mm
- a = 30 mm
- a = 40 mm
- a = 50 mm
- a = 60 mm

Ø 125

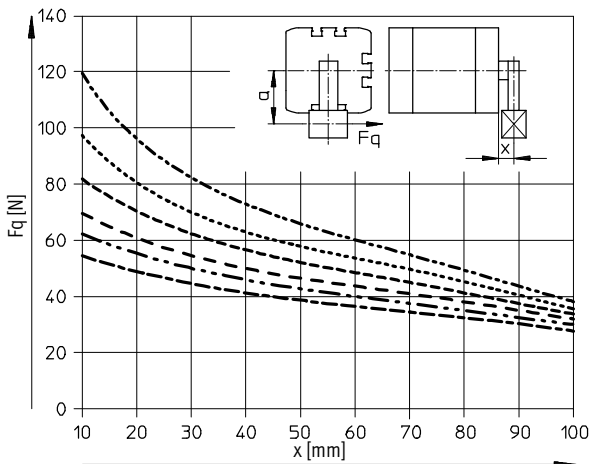

- a = 10 mm
- a = 20 mm
- a = 30 mm
- a = 40 mm
- a = 50 mm
- a = 60 mm

Note

• Torques on the piston rod are to be excluded with projections greater than those shown in the graphs.

• If $a = 0$, the corresponding lateral load line of the basic ADN version can be used (→ page 15).

Compact cylinders ADN, to ISO 21287

Technical data

FESTO

Max. lateral force F_q as a function of the projection x

S1 – Reinforced piston rod

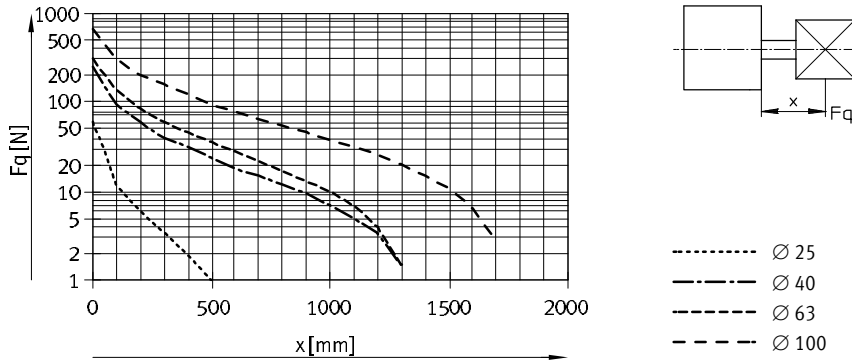

Weight [g]											
Piston Ø	12	16	20	25	32	40	50	63	80	100	125
Product weight with 0 mm stroke	77	79	131	156	265	346	540	722	1300	2154	2880
Additional weight per 10 mm stroke	12	14	21	23	30	37	51	59	79	98	117
Moving load with 0 mm stroke	9	15	30	50	60	80	140	180	400	570	1080
Additional load per 10 mm stroke	2	4	6	6	9	9	16	16	25	25	39

Materials

Sectional view

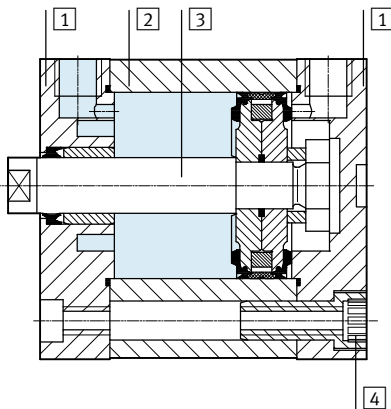

Compact cylinder	Basic version, Q	R8	S6, S10, S11	R3	K10
1 Bearing and end cap					
Ø 12 ... 80	Anodised aluminium				
Ø 100/125	Coated die-cast aluminium				
2 Cylinder barrel	Anodised aluminium				
3 Piston rod	High-alloy steel	Hard-chromium plated tempered steel	High-alloy steel	Anodised aluminium	
4 Flange screws					
Ø 12 ... 16	High-alloy steel			High-alloy steel	–
Ø 20 ... 63	Galvanised steel			Steel, zinc flake coating	Galvanised steel
Ø 80 ... 125	Standard screws, galvanised steel			Standard screws, high-alloy steel	Standard screws, galvanised steel
– Seals	Polyurethane		Fluoro elastomer	Polyurethane	
Note on materials	RoHS-compliant				

Compact cylinders ADN, to ISO 21287

Technical data

FESTO

Dimensions – Basic version

Download CAD data → www.festo.com

∅ 12 ... 63

∅ 80 ... 125

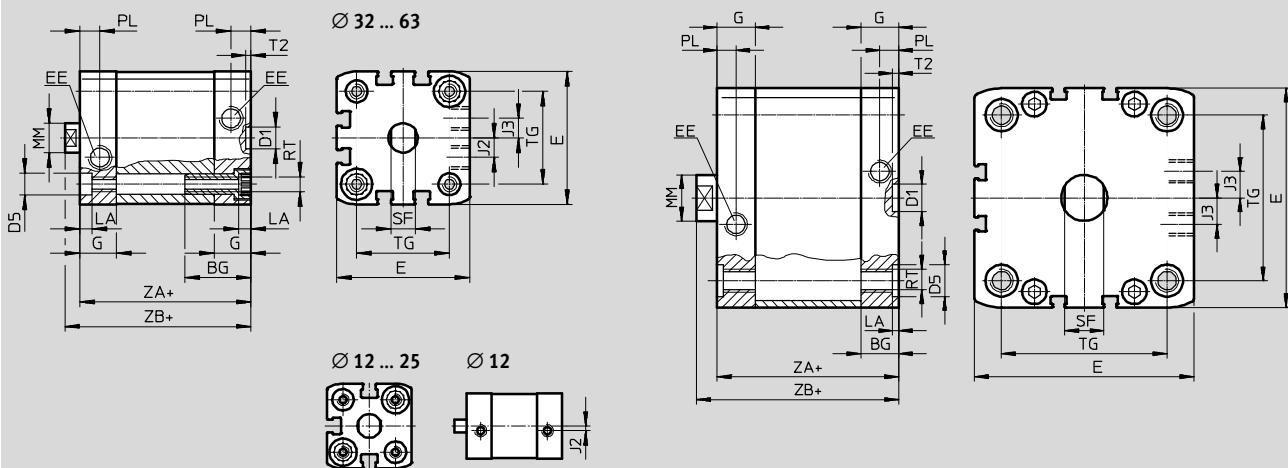

+ = plus stroke length

∅ [mm]	BG min.	D1 ∅ H9	D5 ∅	E	EE	G	J2	J3	LA +0.2
12	17	9	6 ^{F9}	27.5 ^{+0.3}	M5	10.5	2	–	3.5
16				29 ^{+0.3}		11	2.6		
20				35.5 ^{+0.3}		12		5	
25				39.5 ^{+0.3}		15	6		
32	26	47 ^{+0.3}	8						
40		54.5 ^{+0.3}		11.5					
50	27	12 ^{F9}	65.5 ^{+0.3}		20		2.6		
63			75.5 ^{+0.3}						
80	17		15	95.5 ^{+0.6}	21.5				
100				113.5 ^{+0.6}					
125	20	–	134.6 ^{+0.3}	G1/4	20	21.15	–		

∅ [mm]	MM ∅	PL +0.2	RT	SF h13	T2 +0.1	TG ±0.2	ZA ±0.3	ZB	
								+1.2	PPS +1.3
12	6	6	M4	5	2.1	16	35	39.2	–
16	8			7		18		39.7	
20	10		M5	9		22	37	42.5	42.5
25						26	39	44.5	45.3
32	12	8.2	M6	10	32.5	44	50	50.6	
40					38	45	51.1	51.7	
50	16		M8	13	46.5	49	52.7	53.2	
63					56.5		56.5	57	
80	20	10.5	M10	17	2.6	72	54	62.9	63.4
100						89	67	76	76.8
125	25		M12	21		110	81	92	–

Compact cylinders ADN, to ISO 21287

Technical data

FESTO

Dimensions – Variants

Download CAD data → www.festo.com

Basic version

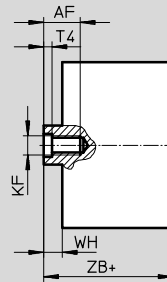
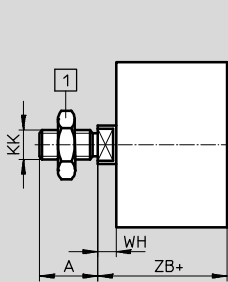

1 Hex nut DIN 439-B
only with $\varnothing 32 \dots 125$

+ = plus stroke length

S2 – Through piston rod

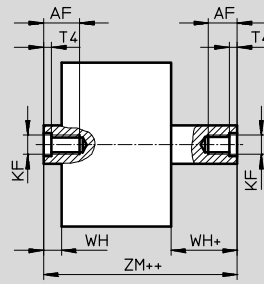
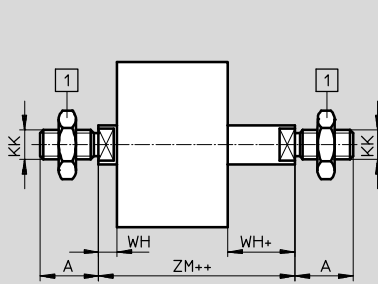

1 Hex nut DIN 439-B
only with $\varnothing 32 \dots 125$

+ = plus stroke length

++ = plus 2x stroke length

S20 – Through, hollow piston rod

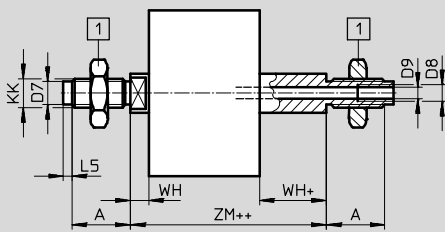

1 Hex nut DIN 439-B
only with $\varnothing 32 \dots 125$

+ = plus stroke length

++ = plus 2x stroke length

K2 – Extended male piston rod thread

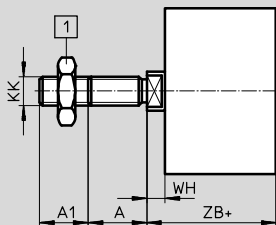

Note

In combination with variants
S2/S20, the piston rod thread is
extended at both ends.

1 Hex nut DIN 439-B
only with $\varnothing 32 \dots 125$

+ = plus stroke length

K5 – Special piston rod thread

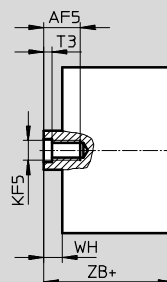
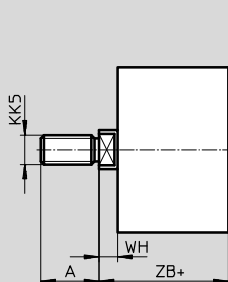

+ = plus stroke length

Compact cylinders ADN, to ISO 21287

Technical data

FESTO

Dimensions – Variants

Download CAD data → www.festo.com

K8 – Extended piston rod

1 Hex nut DIN 439-B only with $\varnothing 32 \dots 125$
 + = plus stroke length

- - Note
 In combination with variants S2/S20, the piston rod is extended at one end.

R8 – Dust protection / TT – Low temperature

1 Hex nut DIN 439-B only with $\varnothing 32 \dots 125$
 + = plus stroke length

\varnothing	A	A1	A2	AF	AF5	B	D7	D8	D9	L5	KF	KF5	KK
[mm]	-0.5			min.	min.	\varnothing	\varnothing		\varnothing				
12	10	1 ... 10	1 ... 300	8	-	-	-	-	-	-	M3	-	M5
16	12			10	-	-	4.5		3.2	3	M4	-	M6
20	16	1 ... 20	1 ... 400	14	12	18	6	-	3.8	2	M6	M5	M8
25				19	16	14	27		8	4.5	3	M8	M6
32	22	1 ... 30	1 ... 500	20	16	31	10	-	6	3.5	M10	M8	M12x1.25
40													
50	40	1 ... 40		25	-	-	-	G1/4	11.7		M16	-	M20x1.5
63													
80	100	1 ... 40		25	-	-	-	G1/4	11.7		M16	-	M20x1.5

\varnothing	KK5	T3	T4	VD	WH			ZB			ZM		
					+1.3	PPS +1.4	R8/TT +1.3	+1.2	PPS +1.3	R8/TT +1.2		PPS	
[mm]													
12	M6	-	1.5	-	4.2	-	-	39.2	-	-	44.5 ^{+0.5}	-	-
16	M8				4.7	-	-	39.7	-	-	45.7 ^{+0.5}	-	-
20	M10x1.25	2	2.6	5.2	5.5	5.5	10.5	42.5	42.5	47.5	49.5 ^{+0.5}	49.5 ^{+0.5}	-
25	M10				5.5			44.5	45.3	49.5	51.5 ^{+0.5}	51.5 ^{+0.5}	
32	M10	2.6	3.3	6.4	6	6.5	12.5	50	50.6	56.5	57.5 ^{+0.5}	58.6 ^{+0.6}	-
40	M12				6.1			51.1	51.7	57.5	58.6 ^{+0.6}	59.7 ^{+0.7}	
50	M12	3.3	4.7	6.4	7.7	8.2	14.7	52.7	53.2	59.7	62.0 ^{+0.6}	63.1 ^{+0.7}	-
63	M16				7.5			56.5	57	63.6	65.4 ^{+0.6}	66.5 ^{+0.7}	
80	M16	4.7	6.1	6.4	8.9	9.4	15.4	62.9	63.4	69.4	73.2 ^{+0.6}	74.3 ^{+0.7}	-
100	M20x1.5				9			76	76.8	82.5	86.4 ^{+0.6}	88 ^{+0.7}	
125	M20	-	7	-	11	-	-	92	-	-	104.4 ^{+0.6}	-	-

Compact cylinders ADN, to ISO 21287

Technical data

FESTO

Dimensions – Variants

Download CAD data → www.festo.com

Q – Square piston rod

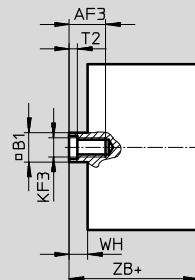
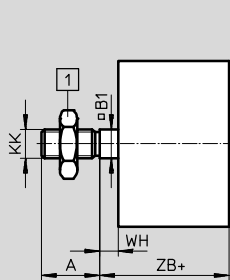

1 Hex nut DIN 439-B
only with $\varnothing 32 \dots 125$

+ = plus stroke length

Q-S2 – Square, through piston rod

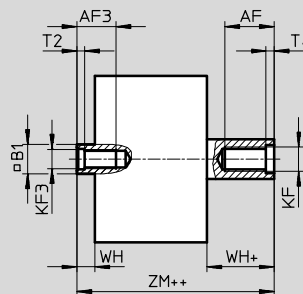
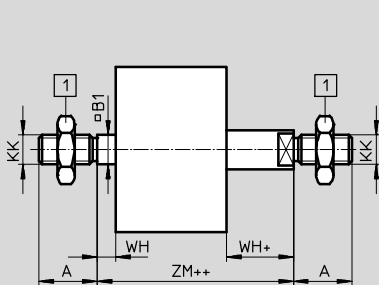

1 Hex nut DIN 439-B
only with $\varnothing 32 \dots 125$

+ = plus stroke length

++ = plus 2x stroke length

Q-S20 – Square, through, hollow piston rod

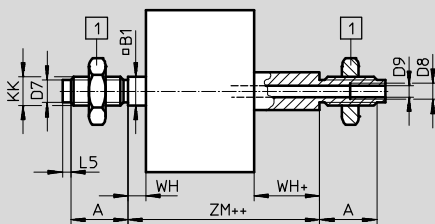

1 Hex nut DIN 439-B
only with $\varnothing 32 \dots 125$

+ = plus stroke length

++ = plus 2x stroke length

Q-K2 – Square piston rod with extended male thread

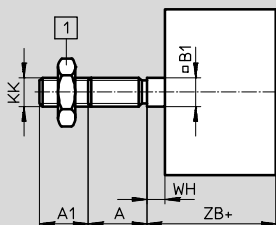

In combination with variants
S2/S20, the piston rod thread is
extended at both ends.

1 Hex nut DIN 439-B
only with $\varnothing 32 \dots 125$

+ = plus stroke length

Q-K5 – Square, special piston rod thread

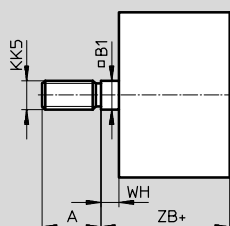

+ = plus stroke length

Compact cylinders ADN, to ISO 21287

Technical data

FESTO

Dimensions – Variants

Download CAD data → www.festo.com

Q-K8 – Square, extended piston rod

Note
 In combination with variants S2/S20, the piston rod is extended at one end on the square piston rod.

1 Hex nut DIN 439-B only with \varnothing 32 ... 125

+ = plus stroke length

\varnothing [mm]	A	A1	A2	AF min.	AF3 min.	B1 □	D7 \varnothing	D8	D9 \varnothing
12	10	1 ... 10	1 ... 300	8	8	5.5	–	–	–
16	12			10	10	7	4.5		3.2
20	16			14	12	9	6		3.8
25		1 ... 20	1 ... 400	16	14	10	8	4.5	
32	22			20	16	12	10	6	
40	28			1 ... 30	1 ... 500	20	20	16	–
50		25	24			20	–	G1/4	11.7
63		40	1 ... 40						

\varnothing [mm]	L5	KF	KF3	KK	KK5	T2	WH +1.3	ZB +1.2	ZM
12	–	M3	M3	M5	M6	1.5	4.2	39.2	44.5 ^{+0.5}
16	3	M4	M4	M6	M8		4.7	39.7	45.7 ^{+0.5}
20	2	M6	M5	M8	M10x1.25 M10	2	5.5	42.5	49.5 ^{+0.5}
25							44.5	51.5 ^{+0.5}	
32	3	M8	M6	M10x1.25	M10	2.6	6	50	57.5 ^{+0.5}
40							6.1	51.1	58.6 ^{+0.6}
50	3.5	M10	M8	M12x1.25	M12	3.3	8.2	53.2	62.8 ^{+0.6}
63							8.1	57.1	66.6 ^{+0.6}
80							8.9	62.9	73.2 ^{+0.6}
100	–	M12	M10	M16x1.5	M16	4.7	9	76	86.4 ^{+0.6}
125							M16	M12	M20x1.5

Compact cylinders ADN, to ISO 21287

Technical data

Dimensions – Variants

Download CAD data → www.festo.com

S1 – Reinforced piston rod

∅ 25

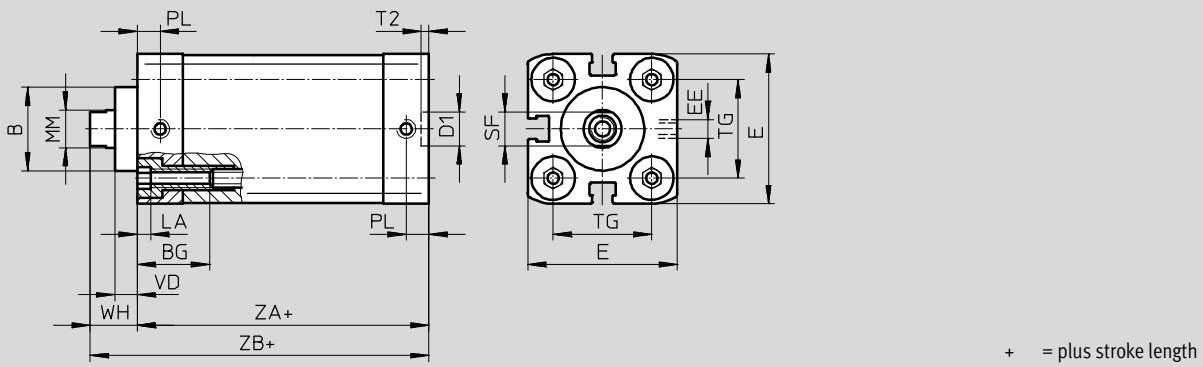

∅ 40 ... 100

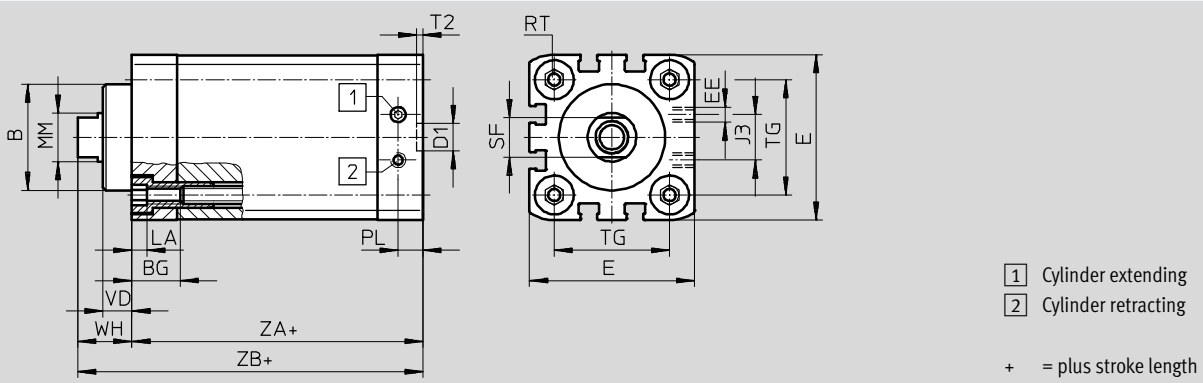

∅	B	BG	D1	E	EE	J3	LA	MM	PL
[mm]	∅	min.	∅					∅	
25	22	15	9	39.5 ^{+0.3}	M5	-	5	10	6
40	35	16		54.5 ^{+0.3}		15		16	8.2
63	42	17	12	75.5 ^{+0.3}	G1/8	23	20	10.5	
100	55		113.5 ^{+0.6}	40		25			

∅	RT	SF	T2	TG	VD	WH	ZA	ZB
[mm]		h13	+0.1	±0.2		+1.3	±0.3	+1.2
25	M5	9	2.1	26	6	11.8	39	50.9
40	M6	13		38	9.5	18	45	62.9
63	M8	17	2.6	56.5	12	21	49	70.2
100	M10	21		89	15.5	26.5	67	93.5

Compact cylinders ADN, to ISO 21287

Technical data

FESTO

Dimensions – Variants

Download CAD data → www.festo.com

S1 – Reinforced piston rod

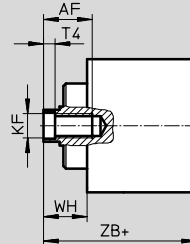
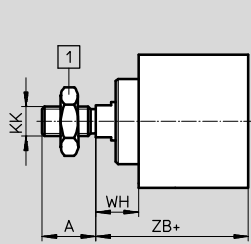

1 Hex nut DIN 439-B
only with \varnothing 40 ... 100

+ = plus stroke length

S1-K2 – Reinforced piston rod with extended male thread

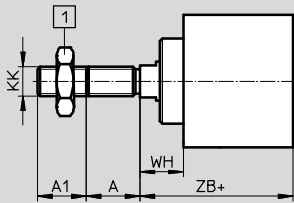

1 Hex nut DIN 439-B
only with \varnothing 40 ... 100

+ = plus stroke length

S1-K5 – Extended piston rod with special piston rod thread

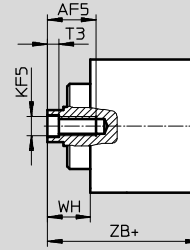
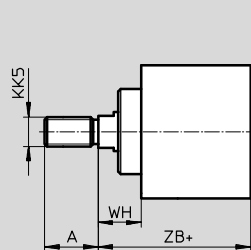

1 Hex nut DIN 439-B
only with \varnothing 40 ... 100

+ = plus stroke length

S1-K8 – Reinforced piston rod with extended piston rod

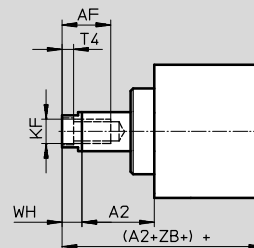
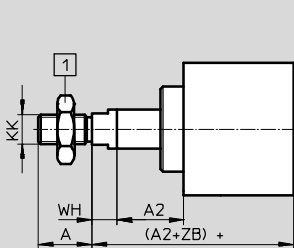

1 Hex nut DIN 439-B
only with \varnothing 40 ... 100

+ = plus stroke length

\varnothing	A	A1	A2	AF	AF5	KF	KF5	KK	KK5	T3	T4	WH	ZB
[mm]	-0.5			min.	min.							+1.3	+1.2
25	16	1 ... 20	1 ... 300	14	12	M6	M5	M8	M10x1.25 M10	2	2.6	11.8	50.9
40	22		1 ... 400	20	16	M10	M8	M12x1.25	M10x1.25 M12	3.3	4.7	18	62.9
63	28				20	M12	M10	M16x1.5	M12x1.25 M16	4.7	6.1	21	70.2
100	40	1 ... 30	1 ... 500	25	-	M16	-	M20x1.5	M16x1.5 M20	-	7	26.5	93.5

Compact cylinders ADN, to ISO 21287

Technical data

FESTO

★ Core product range

Ordering data						
Type	Piston Ø [mm]	Stroke [mm]	I – Piston rod with female thread		A – Male piston rod thread	
			P – Flexible cushioning rings/pads at both ends		P – Flexible cushioning rings/pads at both ends	
			Part No.	Type	Part No.	Type
	12	5	★ 536211	ADN-12-5-I-P-A	★ 536204	ADN-12-5-A-P-A
		10	★ 536212	ADN-12-10-I-P-A	★ 536205	ADN-12-10-A-P-A
		15	★ 536213	ADN-12-15-I-P-A	★ 536206	ADN-12-15-A-P-A
		20	★ 536214	ADN-12-20-I-P-A	★ 536207	ADN-12-20-A-P-A
		25	★ 536215	ADN-12-25-I-P-A	★ 536208	ADN-12-25-A-P-A
		30	★ 536216	ADN-12-30-I-P-A	★ 536209	ADN-12-30-A-P-A
		40	★ 536217	ADN-12-40-I-P-A	★ 536210	ADN-12-40-A-P-A
	16	5	★ 536226	ADN-16-5-I-P-A	★ 536219	ADN-16-5-A-P-A
		10	★ 536227	ADN-16-10-I-P-A	★ 536220	ADN-16-10-A-P-A
		15	★ 536228	ADN-16-15-I-P-A	★ 536221	ADN-16-15-A-P-A
		20	★ 536229	ADN-16-20-I-P-A	★ 536222	ADN-16-20-A-P-A
		25	★ 536230	ADN-16-25-I-P-A	★ 536223	ADN-16-25-A-P-A
		30	★ 536231	ADN-16-30-I-P-A	★ 536224	ADN-16-30-A-P-A
		40	★ 536232	ADN-16-40-I-P-A	★ 536225	ADN-16-40-A-P-A
	20	5	★ 536242	ADN-20-5-I-P-A	★ 536234	ADN-20-5-A-P-A
		10	★ 536243	ADN-20-10-I-P-A	★ 536235	ADN-20-10-A-P-A
		15	★ 536244	ADN-20-15-I-P-A	★ 536236	ADN-20-15-A-P-A
		20	★ 536245	ADN-20-20-I-P-A	★ 536237	ADN-20-20-A-P-A
		25	★ 536246	ADN-20-25-I-P-A	★ 536238	ADN-20-25-A-P-A
		30	★ 536247	ADN-20-30-I-P-A	★ 536239	ADN-20-30-A-P-A
		40	★ 536248	ADN-20-40-I-P-A	★ 536240	ADN-20-40-A-P-A
	25	5	★ 536259	ADN-25-5-I-P-A	★ 536251	ADN-25-5-A-P-A
		10	★ 536260	ADN-25-10-I-P-A	★ 536252	ADN-25-10-A-P-A
		15	★ 536261	ADN-25-15-I-P-A	★ 536253	ADN-25-15-A-P-A
		20	★ 536262	ADN-25-20-I-P-A	★ 536254	ADN-25-20-A-P-A
		25	★ 536263	ADN-25-25-I-P-A	★ 536255	ADN-25-25-A-P-A
		30	★ 536264	ADN-25-30-I-P-A	★ 536256	ADN-25-30-A-P-A
		40	★ 536265	ADN-25-40-I-P-A	★ 536257	ADN-25-40-A-P-A
32	5	★ 536278	ADN-32-5-I-P-A	★ 536268	ADN-32-5-A-P-A	
	10	★ 536279	ADN-32-10-I-P-A	★ 536269	ADN-32-10-A-P-A	
	15	★ 536280	ADN-32-15-I-P-A	★ 536270	ADN-32-15-A-P-A	
	20	★ 536281	ADN-32-20-I-P-A	★ 536271	ADN-32-20-A-P-A	
	25	★ 536282	ADN-32-25-I-P-A	★ 536272	ADN-32-25-A-P-A	
	30	★ 536283	ADN-32-30-I-P-A	★ 536273	ADN-32-30-A-P-A	
	40	★ 536284	ADN-32-40-I-P-A	★ 536274	ADN-32-40-A-P-A	
50	★ 536285	ADN-32-50-I-P-A	★ 536275	ADN-32-50-A-P-A		
60	★ 536286	ADN-32-60-I-P-A	★ 536276	ADN-32-60-A-P-A		
80	★ 536287	ADN-32-80-I-P-A	★ 536277	ADN-32-80-A-P-A		

Festo core product range

★ Generally ready for shipping ex works in 24 hours

☆ Generally ready for shipping ex works in 5 days

Compact cylinders ADN, to ISO 21287

Technical data

FESTO

★ Core product range

Ordering data						
Type	Piston Ø [mm]	Stroke [mm]	I – Piston rod with female thread P – Flexible cushioning rings/pads at both ends		A – Male piston rod thread P – Flexible cushioning rings/pads at both ends	
			Part No.	Type	Part No.	Type
	40	5	★ 536299	ADN-40-5-I-P-A	★ 536289	ADN-40-5-A-P-A
		10	★ 536300	ADN-40-10-I-P-A	★ 536290	ADN-40-10-A-P-A
		15	★ 536301	ADN-40-15-I-P-A	★ 536291	ADN-40-15-A-P-A
		20	★ 536302	ADN-40-20-I-P-A	★ 536292	ADN-40-20-A-P-A
		25	★ 536303	ADN-40-25-I-P-A	★ 536293	ADN-40-25-A-P-A
		30	★ 536304	ADN-40-30-I-P-A	★ 536294	ADN-40-30-A-P-A
		40	★ 536305	ADN-40-40-I-P-A	★ 536295	ADN-40-40-A-P-A
		50	★ 536306	ADN-40-50-I-P-A	★ 536296	ADN-40-50-A-P-A
		60	★ 536307	ADN-40-60-I-P-A	★ 536297	ADN-40-60-A-P-A
	80	★ 536308	ADN-40-80-I-P-A	★ 536298	ADN-40-80-A-P-A	
	50	5	★ 536320	ADN-50-5-I-P-A	★ 536310	ADN-50-5-A-P-A
		10	★ 536321	ADN-50-10-I-P-A	★ 536311	ADN-50-10-A-P-A
		15	★ 536322	ADN-50-15-I-P-A	★ 536312	ADN-50-15-A-P-A
		20	★ 536323	ADN-50-20-I-P-A	★ 536313	ADN-50-20-A-P-A
		25	★ 536324	ADN-50-25-I-P-A	★ 536314	ADN-50-25-A-P-A
		30	★ 536325	ADN-50-30-I-P-A	★ 536315	ADN-50-30-A-P-A
		40	★ 536326	ADN-50-40-I-P-A	★ 536316	ADN-50-40-A-P-A
		50	★ 536327	ADN-50-50-I-P-A	★ 536317	ADN-50-50-A-P-A
		60	★ 536328	ADN-50-60-I-P-A	★ 536318	ADN-50-60-A-P-A
	80	★ 536329	ADN-50-80-I-P-A	★ 536319	ADN-50-80-A-P-A	
	63	10	★ 536342	ADN-63-10-I-P-A	★ 536332	ADN-63-10-A-P-A
		15	★ 536343	ADN-63-15-I-P-A	★ 536333	ADN-63-15-A-P-A
		20	★ 536344	ADN-63-20-I-P-A	★ 536334	ADN-63-20-A-P-A
		25	★ 536345	ADN-63-25-I-P-A	★ 536335	ADN-63-25-A-P-A
		30	★ 536346	ADN-63-30-I-P-A	★ 536336	ADN-63-30-A-P-A
		40	★ 536347	ADN-63-40-I-P-A	★ 536337	ADN-63-40-A-P-A
		50	★ 536348	ADN-63-50-I-P-A	★ 536338	ADN-63-50-A-P-A
		60	★ 536349	ADN-63-60-I-P-A	★ 536339	ADN-63-60-A-P-A
	80	10	★ 536363	ADN-80-10-I-P-A	★ 536353	ADN-80-10-A-P-A
		15	★ 536364	ADN-80-15-I-P-A	★ 536354	ADN-80-15-A-P-A
		20	★ 536365	ADN-80-20-I-P-A	★ 536355	ADN-80-20-A-P-A
		25	★ 536366	ADN-80-25-I-P-A	★ 536356	ADN-80-25-A-P-A
		30	★ 536367	ADN-80-30-I-P-A	★ 536357	ADN-80-30-A-P-A
		40	★ 536368	ADN-80-40-I-P-A	★ 536358	ADN-80-40-A-P-A
		50	★ 536369	ADN-80-50-I-P-A	★ 536359	ADN-80-50-A-P-A
		60	★ 536370	ADN-80-60-I-P-A	★ 536360	ADN-80-60-A-P-A
80		★ 536371	ADN-80-80-I-P-A	★ 536361	ADN-80-80-A-P-A	

Festo core product range

- ★ Generally ready for shipping ex works in 24 hours
- ☆ Generally ready for shipping ex works in 5 days

Compact cylinders ADN, to ISO 21287

Technical data

FESTO

★ Core product range

Ordering data						
Type	Piston Ø [mm]	Stroke [mm]	I – Piston rod with female thread PPS – Pneumatic cushioning, self-adjusting at both ends		A – Male piston rod thread PPS – Pneumatic cushioning, self-adjusting at both ends	
			Part No.	Type	Part No.	Type
	32	10	★ 572646	ADN-32-10-I-PPS-A	★ 572655	ADN-32-10-A-PPS-A
		15	★ 572647	ADN-32-15-I-PPS-A	★ 572656	ADN-32-15-A-PPS-A
		20	★ 572648	ADN-32-20-I-PPS-A	★ 572657	ADN-32-20-A-PPS-A
		25	★ 572649	ADN-32-25-I-PPS-A	★ 572658	ADN-32-25-A-PPS-A
		30	★ 572650	ADN-32-30-I-PPS-A	★ 572659	ADN-32-30-A-PPS-A
		40	★ 572651	ADN-32-40-I-PPS-A	★ 572660	ADN-32-40-A-PPS-A
		50	★ 572652	ADN-32-50-I-PPS-A	★ 572661	ADN-32-50-A-PPS-A
		60	★ 572653	ADN-32-60-I-PPS-A	★ 572662	ADN-32-60-A-PPS-A
	80	★ 572654	ADN-32-80-I-PPS-A	★ 572663	ADN-32-80-A-PPS-A	
	40	10	★ 572664	ADN-40-10-I-PPS-A	★ 572673	ADN-40-10-A-PPS-A
		15	★ 572665	ADN-40-15-I-PPS-A	★ 572674	ADN-40-15-A-PPS-A
		20	★ 572666	ADN-40-20-I-PPS-A	★ 572675	ADN-40-20-A-PPS-A
		25	★ 572667	ADN-40-25-I-PPS-A	★ 572676	ADN-40-25-A-PPS-A
		30	★ 572668	ADN-40-30-I-PPS-A	★ 572677	ADN-40-30-A-PPS-A
		40	★ 572669	ADN-40-40-I-PPS-A	★ 572678	ADN-40-40-A-PPS-A
		50	★ 572670	ADN-40-50-I-PPS-A	★ 572679	ADN-40-50-A-PPS-A
		60	★ 572671	ADN-40-60-I-PPS-A	★ 572680	ADN-40-60-A-PPS-A
	80	★ 572672	ADN-40-80-I-PPS-A	★ 572681	ADN-40-80-A-PPS-A	
	50	10	★ 572682	ADN-50-10-I-PPS-A	★ 572691	ADN-50-10-A-PPS-A
		15	★ 572683	ADN-50-15-I-PPS-A	★ 572692	ADN-50-15-A-PPS-A
		20	★ 572684	ADN-50-20-I-PPS-A	★ 572693	ADN-50-20-A-PPS-A
		25	★ 572685	ADN-50-25-I-PPS-A	★ 572694	ADN-50-25-A-PPS-A
		30	★ 572686	ADN-50-30-I-PPS-A	★ 572695	ADN-50-30-A-PPS-A
		40	★ 572687	ADN-50-40-I-PPS-A	★ 572696	ADN-50-40-A-PPS-A
		50	★ 572688	ADN-50-50-I-PPS-A	★ 572697	ADN-50-50-A-PPS-A
		60	★ 572689	ADN-50-60-I-PPS-A	★ 572698	ADN-50-60-A-PPS-A
	80	★ 572690	ADN-50-80-I-PPS-A	★ 572699	ADN-50-80-A-PPS-A	
	63	10	★ 572700	ADN-63-10-I-PPS-A	★ 572709	ADN-63-10-A-PPS-A
15		★ 572701	ADN-63-15-I-PPS-A	★ 572710	ADN-63-15-A-PPS-A	
20		★ 572702	ADN-63-20-I-PPS-A	★ 572711	ADN-63-20-A-PPS-A	
25		★ 572703	ADN-63-25-I-PPS-A	★ 572712	ADN-63-25-A-PPS-A	
30		★ 572704	ADN-63-30-I-PPS-A	★ 572713	ADN-63-30-A-PPS-A	
40		★ 572705	ADN-63-40-I-PPS-A	★ 572714	ADN-63-40-A-PPS-A	
50		★ 572706	ADN-63-50-I-PPS-A	★ 572715	ADN-63-50-A-PPS-A	
60		★ 572707	ADN-63-60-I-PPS-A	★ 572716	ADN-63-60-A-PPS-A	
80	★ 572708	ADN-63-80-I-PPS-A	★ 572717	ADN-63-80-A-PPS-A		
80	10	★ 572718	ADN-80-10-I-PPS-A	★ 572727	ADN-80-10-A-PPS-A	
	15	★ 572719	ADN-80-15-I-PPS-A	★ 572728	ADN-80-15-A-PPS-A	
	20	★ 572720	ADN-80-20-I-PPS-A	★ 572729	ADN-80-20-A-PPS-A	
	25	★ 572721	ADN-80-25-I-PPS-A	★ 572730	ADN-80-25-A-PPS-A	
	30	★ 572722	ADN-80-30-I-PPS-A	★ 572731	ADN-80-30-A-PPS-A	
	40	★ 572723	ADN-80-40-I-PPS-A	★ 572732	ADN-80-40-A-PPS-A	
	50	★ 572724	ADN-80-50-I-PPS-A	★ 572733	ADN-80-50-A-PPS-A	
	60	★ 572725	ADN-80-60-I-PPS-A	★ 572734	ADN-80-60-A-PPS-A	
80	★ 572726	ADN-80-80-I-PPS-A	★ 572735	ADN-80-80-A-PPS-A		

Festo core product range

- ★ Generally ready for shipping ex works in 24 hours
- ☆ Generally ready for shipping ex works in 5 days

Compact cylinders ADN, to ISO 21287

Technical data

Ordering data						
Type	Piston Ø [mm]	Stroke [mm]	I – Piston rod with female thread P – Flexible cushioning rings/pads at both ends		A – Male piston rod thread P – Flexible cushioning rings/pads at both ends	
			Part No.	Type	Part No.	Type
	100	10	536384	ADN-100-10-I-P-A	536374	ADN-100-10-A-P-A
		15	536385	ADN-100-15-I-P-A	536375	ADN-100-15-A-P-A
		20	536386	ADN-100-20-I-P-A	536376	ADN-100-20-A-P-A
		25	536387	ADN-100-25-I-P-A	536377	ADN-100-25-A-P-A
		30	536388	ADN-100-30-I-P-A	536378	ADN-100-30-A-P-A
		40	536389	ADN-100-40-I-P-A	536379	ADN-100-40-A-P-A
		50	536390	ADN-100-50-I-P-A	536380	ADN-100-50-A-P-A
		60	536391	ADN-100-60-I-P-A	536381	ADN-100-60-A-P-A
		80	536392	ADN-100-80-I-P-A	536382	ADN-100-80-A-P-A

Ordering data						
Type	Piston Ø [mm]	Stroke [mm]	I – Piston rod with female thread PPS – Pneumatic cushioning, self-adjusting at both ends		A – Male piston rod thread PPS – Pneumatic cushioning, self-adjusting at both ends	
			Part No.	Type	Part No.	Type
	20	10	577158	ADN-20-10-I-PPS-A	577166	ADN-20-10-A-PPS-A
		15	577159	ADN-20-15-I-PPS-A	577167	ADN-20-15-A-PPS-A
		20	577160	ADN-20-20-I-PPS-A	577168	ADN-20-20-A-PPS-A
		25	577161	ADN-20-25-I-PPS-A	577169	ADN-20-25-A-PPS-A
		30	577162	ADN-20-30-I-PPS-A	577170	ADN-20-30-A-PPS-A
		40	577163	ADN-20-40-I-PPS-A	577171	ADN-20-40-A-PPS-A
		50	577164	ADN-20-50-I-PPS-A	577172	ADN-20-50-A-PPS-A
		60	577165	ADN-20-60-I-PPS-A	577173	ADN-20-60-A-PPS-A
	25	10	577174	ADN-25-10-I-PPS-A	577182	ADN-25-10-A-PPS-A
		15	577175	ADN-25-15-I-PPS-A	577183	ADN-25-15-A-PPS-A
		20	577176	ADN-25-20-I-PPS-A	577184	ADN-25-20-A-PPS-A
		25	577177	ADN-25-25-I-PPS-A	577185	ADN-25-25-A-PPS-A
		30	577178	ADN-25-30-I-PPS-A	577186	ADN-25-30-A-PPS-A
		40	577179	ADN-25-40-I-PPS-A	577187	ADN-25-40-A-PPS-A
		50	577180	ADN-25-50-I-PPS-A	577188	ADN-25-50-A-PPS-A
		60	577181	ADN-25-60-I-PPS-A	577189	ADN-25-60-A-PPS-A
	100	15	577191	ADN-100-15-I-PPS-A	577200	ADN-100-15-A-PPS-A
		20	577192	ADN-100-20-I-PPS-A	577201	ADN-100-20-A-PPS-A
		25	577193	ADN-100-25-I-PPS-A	577202	ADN-100-25-A-PPS-A
		30	577194	ADN-100-30-I-PPS-A	577203	ADN-100-30-A-PPS-A
		40	577195	ADN-100-40-I-PPS-A	577204	ADN-100-40-A-PPS-A
		50	577196	ADN-100-50-I-PPS-A	577205	ADN-100-50-A-PPS-A
		60	577197	ADN-100-60-I-PPS-A	577206	ADN-100-60-A-PPS-A
		80	577198	ADN-100-80-I-PPS-A	577207	ADN-100-80-A-PPS-A

Compact cylinders ADN, to ISO 21287

Ordering data – Modular products, basic version and variants



Ordering table									
Size	12	16	20	25	32	40	Condi- tions	Code	Enter code
M Module No.	536203	536218	536233	536250	536267	536288			
Function	Compact cylinder, double-acting, based on ISO 21287							ADN	ADN
Piston Ø [mm]	12	16	20	25	32	40		★ -...	
Stroke [mm]	1 ... 300				1 ... 400			★ -...	
Piston rod thread	Male thread							★ -A	
	Female thread						1	★ -I	
Cushioning	Flexible cushioning rings/pads at both ends							★ -P	
	-		Pneumatic cushioning, self-adjusting at both ends				8	★ -PPS	
Position sensing	Via proximity sensor							★ -A	-A

- 1 I Not with piston rod type S20.
Not with extended male thread K2
- 8 PPS Not with improved running performance K10, temperature resistance S6,
low temperature TT, wiper seal R8
Minimum stroke 5 mm

- M Mandatory data
- O Options

Transfer order code

Festo core product range

- ★ Generally ready for shipping ex works in 24 hours
- ☆ Generally ready for shipping ex works in 5 days

Compact cylinders ADN, to ISO 21287

Ordering data – Modular products, basic version and variants

Ordering table									
Size	12	16	20	25	32	40	Condi- tions	Code	Enter code
0 Piston rod type	Through piston rod						2	★ -S2	
	[mm]	Through, hollow piston rod 1 ... 300			1 ... 400		2	-S20	
Extended male thread [mm]	Piston rod with extended male thread							...K2	
Piston rod with special thread	Male thread	M6	M8	M10x1.25 M10	M10x1.25 M10	M10 M12	M10 M12	-“...”K5	
	Female thread	-	-	M5	M5	M6	M6		
Extended piston rod [mm]	Extended piston rod 1 ... 300				1 ... 400		3	★ ...K8	
Improved running performance	-	-	Smooth anodised aluminium coated piston rod				4	-K10	
Temperature resistance	Heat-resistant seals up to max. 120 °C							★ -S6	
Corrosion protection	High corrosion protection						5	★ -R3	
Captive rating plate	Laser etched rating plate							-TL	
Low temperature [°C]	-	-	-40 ... +80				6 7	-TT	
Wiper seal	-	-	Dust protection				6	-R8	

2 S2, S20 Not with improved running performance K10.

Not with corrosion protection R3.

Not with wiper seal R8

3 K8 The sum of the stroke length and piston rod extension must not exceed the maximum permissible stroke length

4 K10 Not with extended male thread K2.
Not with special piston rod thread K5.
Not with corrosion protection R3

5 R3 Not with captive rating plate TL.

Not with wiper seal R8

6 TT, R8 Not with improved running performance K10.

Not with temperature resistance S6

7 TT Not with wiper seal R8

 Note

NSF-H1 lubricants are used in combination with R3 and in combination with R3 and K2, K5 or K8.

M Mandatory data

O Options

Transfer order code

- [] - [] - [] - [] - [] - [] - [] - [] - [] - []

Festo core product range

★ Generally ready for shipping ex works in 24 hours

☆ Generally ready for shipping ex works in 5 days

Compact cylinders ADN, to ISO 21287

Ordering data – Modular products, basic version and variants

Ordering table									
Size	50	63	80	100	125	Condi- tions	Code	Enter code	
M Module No.	536309	536330	536351	536372	536393				
Function	Compact cylinder, double-acting, based on ISO 21287							ADN	ADN
Piston Ø [mm]	50	63	80	-	-		★ -...		
	-	-	-	100	125		-...		
Stroke [mm]	1 ... 400		1 ... 500				★ -...		
Piston rod thread	Male thread							★ -A	
	Female thread						1	★ -I	
Cushioning	Flexible cushioning rings/pads at both ends							★ -P	
	Pneumatic cushioning, self-adjusting at both ends				-		8	★ -PPS	
Position sensing	Via proximity sensor							★ -A	-A

- 1** I Not with piston rod type S20.
Not with extended male thread K2
- 8** PPS Not with improved running performance K10, temperature resistance S6,
low temperature TT, wiper seal R8
Minimum stroke 5 mm

- M** Mandatory data
- O** Options

Transfer order code

ADN - - - - - **A**

Festo core product range

- ★ Generally ready for shipping ex works in 24 hours
- ☆ Generally ready for shipping ex works in 5 days

Compact cylinders ADN, to ISO 21287

Ordering data – Modular products, basic version and variants

Ordering table									
Size	50	63	80	100	125	Condi- tions	Code	Enter code	
[O] Piston rod type	Through piston rod					[2]	★-S2		
	Through, hollow piston rod					[2]	-S20		
[mm]	1 ... 400		1 ... 500						
Extended male thread	Piston rod with extended male thread								
[mm]	1 ... 20		1 ... 30		1 ... 40		-...K2		
Piston rod with special thread	Male thread	M12 M16	M12 M16	M16 M20 M20x1.5	M16 M20 M20x1.5	M20		-“...”K5	
	Female thread	M8	M8	M10	M10	-			
Extended piston rod	Extended piston rod								
[mm]	1 ... 400		1 ... 500			[3]	★-...K8		
Improved running performance	Smooth anodised aluminium coated piston rod								
[mm]	2 ... 400		5 ... 400	5 ... 500			[4]	-K10	
Temperature resistance	Heat-resistant seals up to max. 120 °C							★-S6	
Corrosion protection	High corrosion protection						[5]	★-R3	
Captive rating plate	Laser etched rating plate							-TL	
Low temperature	-40 ... +80							[6] [7]	-TT
Wiper seal	Dust protection							[6]	-R8

- [2] **S2, S20** Not with improved running performance K10.
Not with corrosion protection R3.
Not with wiper seal R8
- [3] **K8** The sum of the stroke length and piston rod extension must not exceed the maximum permissible stroke length
- [4] **K10** Not with extended male thread K2.
Not with special piston rod thread K5.
Not with corrosion protection R3
- [5] **R3** Not with captive rating plate TL.
Not with wiper seal R8
- [6] **TT, R8** Not with improved running performance K10.
Not with temperature resistance S6
- [7] **TT** Not with wiper seal R8

 Note
NSF-H1 lubricants are used in combination with R3 and in combination with R3 and K2, K5 or K8.

- [M] Mandatory data
- [O] Options

Transfer order code

- [] - [] - [] - [] - [] - [] - [] - [] - [] - []

Festo core product range ★ Generally ready for shipping ex works in 24 hours
 ☆ Generally ready for shipping ex works in 5 days

Compact cylinders ADN, to ISO 21287

Ordering data – Modular products, S10 – Version with constant motion, S11 – Version with low friction

Ordering table									
Size	12	16	20	25	32	40	Condi- tions	Code	Enter code
M Module No.	536203	536218	536233	536250	536267	536288			
Function	Compact cylinder, double-acting, based on ISO 21287							ADN	ADN
Piston Ø [mm]	12	16	20	25	32	40		-...	
Stroke [mm]	1 ... 300				1 ... 400				
Piston rod thread	Male thread							-A	
	Female thread						1	-I	
Cushioning	Flexible cushioning rings/pads at both ends							-P	-P
Position sensing	Via proximity sensor							-A	-A
O Male thread extended	Extended male piston rod thread								
	[mm] 1 ... 10		1 ... 20					-...K2	
Special piston rod thread	Male thread	M6	M8	M10x1.25	M10x1.25	M10	M10	-“...”K5	
	Female thread	-	-	M5	M5	M6	M6		
Piston rod extended	[mm] 1 ... 300				1 ... 400		2	-...K8	
Improved running performance	-		Smooth anodised aluminium coated piston rod				3	-K10	
Constant motion	Slow speed (constant motion at low piston speeds)						4	-S10	
	[mm] 20 ... 300				20 ... 400				
Low friction	Low friction						5	-S11	
Corrosion protection	High corrosion protection						6	-R3	
Captive rating plate	Laser etched rating plate							-TL	

- 1 I** Not with extended male thread K2
- 2 K8** The sum of the stroke length and piston rod extension must not exceed the maximum permissible stroke length
- 3 K10** Not with extended male thread K2
Not with special piston rod thread K5
Not with corrosion protection R3
- 4 S10** Not with low friction S11
- 5 S11** Not with constant motion S10
- 6 R3** Not with captive rating plate TL

 Note
NSF-H1 lubricants are used in combination with R3 and in combination with R3 and K2, K5 or K8.

- M** Mandatory data
- O** Options

Transfer order code

ADN - - - - **P** - **A** - - - - - - - - - -

Compact cylinders ADN, to ISO 21287

Ordering data – Modular products, S10 – Version with constant motion, S11 – Version with low friction

Ordering table										
Size	50	63	80	100	125	Condi- tions	Code		Enter code	
M Module No.	536309	536330	536351	536372	536393					
Function	Compact cylinder, double-acting, based on ISO 21287							ADN		ADN
Piston Ø [mm]	50	63	80	100	125		-...			
Stroke [mm]	1 ... 400		1 ... 500				-...			
Piston rod thread	Male thread							-A		
	Female thread						1	-I		
Cushioning	Flexible cushioning rings/pads at both ends							-P		-P
Position sensing	Via proximity sensor							-A		-A
O Male thread extended	Extended male piston rod thread									
[mm]	1 ... 20		1 ... 30		1 ... 40			-...K2		
Special piston rod thread	Male thread	M12	M12	M16	M16	M20		-“...”K5		
		M16	M16	M20	M20	M20x1.5	M20x1.5			
	Female thread	M8	M8	M10	M10	-				
Piston rod extended	Extended piston rod									
[mm]	1 ... 400		1 ... 500				2	-...K8		
Improved running performance	Smooth anodised aluminium coated piston rod						3	-K10		
	Restricted stroke									
[mm]	2 ... 400	5 ... 400	5 ... 500							
Constant motion	Slow speed (constant motion at low piston speeds)						4	-S10		
	Restricted stroke									
[mm]	20 ... 400		20 ... 500							
Low friction	Low friction						5	-S11		
Corrosion protection	High corrosion protection						6	-R3		
Captive rating plate	Laser etched rating plate							-TL		

- 1 I** Not with extended male thread K2
- 2 K8** The sum of the stroke length and piston rod extension must not exceed the maximum permissible stroke length
- 3 K10** Not with extended male thread K2
Not with special piston rod thread K5
Not with corrosion protection R3
- 4 S10** Not with low friction S11
- 5 S11** Not with constant motion S10
- 6 R3** Not with captive rating plate TL

 - Note
NSF-H1 lubricants are used in combination with R3 and in combination with R3 and K2, K5 or K8.

- M** Mandatory data
- O** Options

Transfer order code

ADN - - - - **P** - **A** - - - - - - - - - -

Compact cylinders ADN, to ISO 21287

Ordering data – Modular products, Q – Version with square piston rod, non-rotating



Ordering table									
Size	12	16	20	25	32	40	Condi- tions	Code	Enter code
M Module No.	536203	536218	536233	536250	536267	536288			
Function	Compact cylinder, double-acting, based on ISO 21287							ADN	ADN
Piston Ø [mm]	12	16	20	25	32	40		★ -...	
Stroke [mm]	1 ... 300				1 ... 400			★ -...	
Piston rod thread	Male thread							★ -A	
	Female thread						¹	★ -I	
Cushioning	Flexible cushioning rings/pads at both ends							★ -P	-P
Position sensing	Via proximity sensor							★ -A	-A
O Protection against torsion	Square piston rod							★ -Q	-Q
Type of piston rod	Through piston rod							★ -S2	
	-	Through, hollow piston rod Restricted stroke 1 ... 200				1 ... 300			-S20
Male thread extended [mm]	1 ... 10			1 ... 20				-...K2	
Special piston rod thread	Male thread	M6	M8	M10x1.25 M10	M10x1.25 M10	M10	M10	-“...”K5	
Piston rod extended [mm]	1 ... 300				1 ... 400		²	★ -...K8	
Temperature resistance	Heat-resistant seals up to max. 120 °C							★ -S6	
Corrosion protection	High corrosion protection						³	★ -R3	
Captive rating plate	Laser etched rating plate							-TL	

¹ I Not with piston rod type S20
Not with extended male thread K2

² K8 The sum of the stroke length and piston rod extension must not exceed the maximum permissible stroke length

³ R3 Not with captive rating plate TL.



Note
NSF-H1 lubricants are used in combination with R3 and in combination with R3 and Q, K2, K5 or K8.

M Mandatory data

O Options

Transfer order code

Festo core product range

★ Generally ready for shipping ex works in 24 hours

☆ Generally ready for shipping ex works in 5 days

Compact cylinders ADN, to ISO 21287

Ordering data – Modular products, Q – Version with square piston rod, non-rotating

Ordering table									
Size	50	63	80	100	125	Condi- tions	Code		Enter code
M Module No.	536309	536330	536351	536372	536393				
Function	Compact cylinder, double-acting, based on ISO 21287							ADN	ADN
Piston Ø [mm]	50	63	80	100	125		★ -...		
Stroke [mm]	1 ... 400		1 ... 500				★ -...		
Piston rod thread	Male thread						★ -A		
	Female thread					[1]	★ -I		
Cushioning	Flexible cushioning rings/pads at both ends						★ -P	-P	
Position sensing	Via proximity sensor						★ -A	-A	
O Protection against torsion	Square piston rod						★ -Q	-Q	
Type of piston rod [mm]	Through piston rod						★ -S2		
	Through, hollow piston rod Restricted stroke		1 ... 400				-S20		
Male thread extended [mm]	1 ... 300		1 ... 400						
Special piston rod thread	Extended male piston rod thread								
	1 ... 20		1 ... 30		1 ... 40		-...K2		
Male thread	M12	M12	M16	M16	M20		-“...”K5		
Piston rod extended [mm]	1 ... 400		1 ... 500			[2]	★ -...K8		
Temperature resistance	Heat-resistant seals up to max. 120 °C						★ -S6		
Corrosion protection	High corrosion protection					[3]	★ -R3		
Captive rating plate	Laser etched rating plate						-TL		

[1] I Not with piston rod type S20
Not with extended male thread K2

[2] K8 The sum of the stroke length and piston rod extension must not exceed the maximum permissible stroke length

[3] R3 Not with captive rating plate TL.

 Note
NSF-H1 lubricants are used in combination with R3 and in combination with R3 and Q, K2, K5 or K8.

- M** Mandatory data
- O** Options

Transfer order code

Festo core product range

- ★ Generally ready for shipping ex works in 24 hours
- ☆ Generally ready for shipping ex works in 5 days

Compact cylinders ADN, to ISO 21287



Ordering data – Modular products, S1 – Version with reinforced piston rod

Ordering table							
Size	25	40	63	100	Condi- tions	Code	Enter code
M Module No.	536250	536288	536330	536372			
Function	Compact cylinder, double-acting, based on ISO 21287					ADN	ADN
Piston Ø [mm]	25	40	63	100		-...	
Stroke [mm]	5 ... 300	10 ... 400		10 ... 500		-...	
Piston rod thread	Male thread					-A	
	Female thread				1	-I	
Cushioning	Flexible cushioning rings/pads at both ends					-P	-P
Position sensing	Via proximity sensor					-A	-A
O Male thread extended [mm]	Extended male piston rod thread 1 ... 20			1 ... 30		-...K2	
Special piston rod thread	Male thread	M10x1.25 M10	M10x1.25 M12	M12x1.25 M16	M16x1.5 M20	-“...”K5	
	Female thread	M5	M8	M10	-		
Piston rod extended [mm]	Extended piston rod 1 ... 300		1 ... 400	1 ... 500	2	-...K8	
Temperature resistance	Heat-resistant seals up to max. 120 °C					-S6	
Reinforced piston rod	Reinforced piston rod or extended piston rod bearing					-S1	-S1
Captive rating plate	Laser etched rating plate					-TL	

1 I Not with extended male thread K2

2 K8 The sum of the stroke length and piston rod extension must not exceed the maximum permissible stroke length

M Mandatory data

O Options

Transfer order code

ADN - - - - **P** - **A** - - - - - - **S1** -

Compact cylinders ADN-KP, standard port pattern, with clamping unit

Type codes

ADN – 20 – 50 – KP – A – P – A – K2

Type	
Double-acting	
ADN	Compact cylinder
Piston Ø [mm]	
20	
Stroke [mm]	
50	
Clamping unit	
KP	Integrated
Piston rod thread	
A	Male thread
I	Female thread
Cushioning	
P	Flexible cushioning rings/pads at both ends
Position sensing	
A	Via proximity sensor
Variant	
K2	Extended male piston rod thread
K5	Special piston rod thread
K8	Extended piston rod
TL	Captive rating plate

Compact cylinders ADN-KP, standard port pattern, with clamping unit

FESTO

Technical data

Function

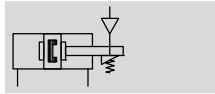

- \varnothing - Diameter
20 ... 100 mm

- | - Stroke length
10 ... 500 mm

Variants



K2



K5



K8



-  - Note

Additional measures are required for use in safety-related control systems; in Europe, for example, the standards listed under the EC Machinery Directive must be observed. Without

additional measures in accordance with statutory minimum requirements, the product is not suitable for use in safety-related sections of control systems.

General technical data								
Piston \varnothing	20	25	32	40	50	63	80	100
Pneumatic connection								
Cylinder	M5	M5	G $\frac{1}{8}$	G $\frac{1}{8}$	G $\frac{1}{8}$	G $\frac{1}{8}$	G $\frac{1}{8}$	G $\frac{1}{8}$
KP	M5	M5	M5	G $\frac{1}{8}$	G $\frac{1}{8}$	G $\frac{1}{8}$	G $\frac{1}{8}$	G $\frac{1}{8}$
Female piston rod thread								
-	M6	M8	M10	M12				
K5	M5	M6	M8	M10				
Male piston rod thread								
-	M8	M10x1.25	M12x1.25	M16x1.5				
K5	M10, M10x1.25	M10, M12	M12, M16	M16, M20, M20x1.5				
Axial play under load [mm]	0.5				0.8			
Constructional design	Piston							
	Piston rod							
	Cylinder barrel							
Cushioning	Flexible cushioning rings/pads at both ends							
Position sensing	Via proximity sensor							
Type of mounting	Via through-holes							
	Via female threads							
	Via accessories							
Mounting position	Any							
Clamping type with effective direction of action	From both sides							

Operating and environmental conditions	
Operating medium	Compressed air in accordance with ISO 8573-1:2010 [7:4:4]
Note on operating/pilot medium	Operation with lubricated medium possible (in which case lubricated operation will always be required)
Operating pressure [bar]	1.5 ... 10
Min. release pressure [bar]	3
Ambient temperature ¹⁾ [°C]	-10 ... +80
Corrosion resistance class CRC ²⁾	2

1) Note operating range of proximity sensors

2) Corrosion resistance class CRC 2 to Festo standard FN 940070

Moderate corrosion stress. Indoor applications in which condensation may occur. External visible parts with primarily decorative requirements for the surface and which are in direct contact with the ambient atmosphere typical for industrial applications.

Compact cylinders ADN-KP, standard port pattern, with clamping unit

Technical data

Impact energy [J]								
Piston Ø	20	25	32	40	50	63	80	100
Max. impact energy at the end positions	0.2	0.3	0.4	0.7	1	1.3	1.8	2.5

Permissible impact velocity:

$$v_{perm.} = \sqrt{\frac{2 \times E_{perm.}}{m_{dead} + m_{load}}}$$

$v_{perm.}$ Permissible impact velocity
 $E_{perm.}$ Max. impact energy
 m_{dead} Moving load (drive)
 m_{load} Moving work load

 Note
 These specifications represent the maximum values which can be reached. Note the maximum permitted impact energy.

Maximum permissible load:

$$m_{load} = \frac{2 \times E_{perm.}}{v^2} - m_{dead}$$

Forces [N]								
Piston Ø	20	25	32	40	50	63	80	100
Theoretical force at 6 bar, advancing	188	295	483	754	1178	1870	3016	4712
Theoretical force at 6 bar, retracting	141	247	415	633	990	1682	2721	4418
Static holding force	350	350	600	1000	1400	2000	5000	5000

 Note
 The specified holding force refers to a static load. If this value is exceeded, slippage may occur. Dynamic forces occurring during operation must not exceed the static holding force. The clamping unit is not backlash-free in the clamped condition if varying loads are applied to the piston rod.

Activation:
 The clamping unit may only be released if the forces at the piston have reached equilibrium. Otherwise, there is a risk of accidents due to sudden movement of the piston rod. Blocking off the air supply at both ends (e.g. with a 5/3-way valve) does not provide any safety.

Max. lateral force Fq as a function of the projection x

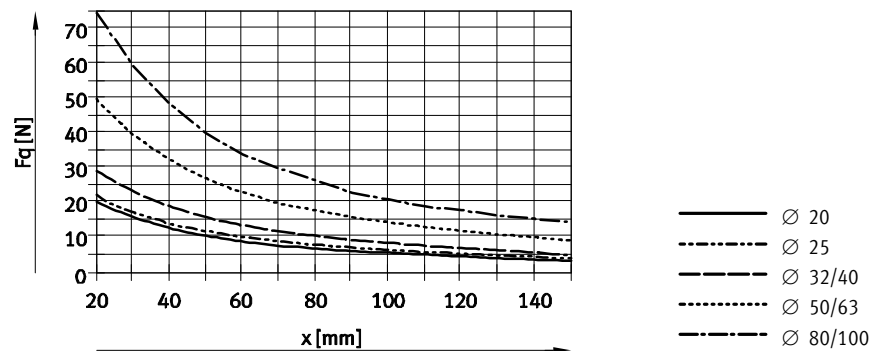

Weight [g]								
Piston Ø	20	25	32	40	50	63	80	100
Product weight with 0 mm stroke	282	344	503	789	1268	1894	3973	5497
Additional weight per 10 mm stroke	22	26	29	45	60	68	93	112
Moving load with 0 mm stroke	53	63	100	173	296	368	755	932
Additional load per 10 mm stroke	6	6	9	16	25	25	39	39

Compact cylinders ADN-KP, standard port pattern, with clamping unit

Technical data

Materials

Sectional view

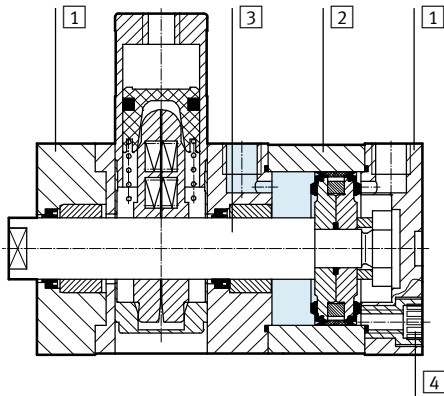

Compact cylinder		
1	Cover	Anodised aluminium
2	Cylinder barrel	Anodised aluminium
3	Piston rod	High-alloy steel
4	Flange screws	∅ 20 ... 63 Galvanised steel
		∅ 80 ... 100 Standard screws, galvanised steel
-	Seals	Polyurethane, nitrile rubber
	Note on materials	RoHS compliant

Compact cylinders ADN-KP, standard port pattern, with clamping unit

Technical data

Dimensions – Basic version

Download CAD data → www.festo.com

∅ 20 ... 63

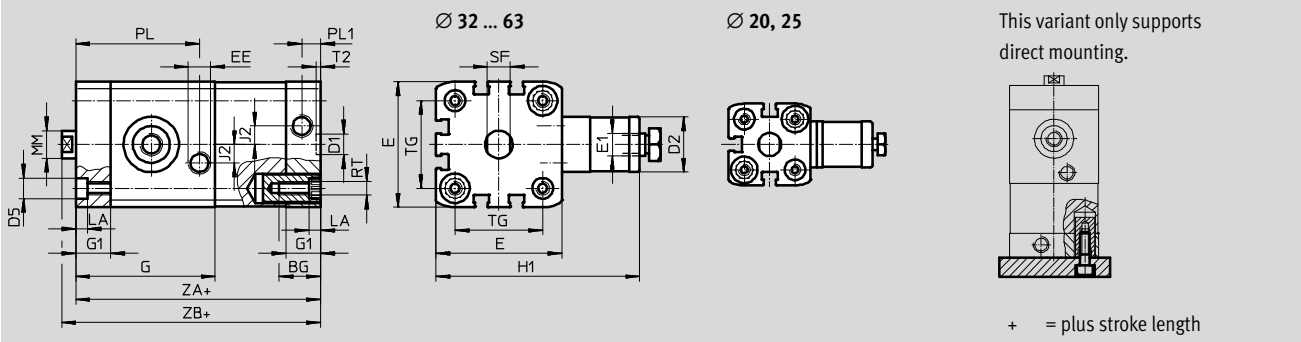

∅ 80, 100

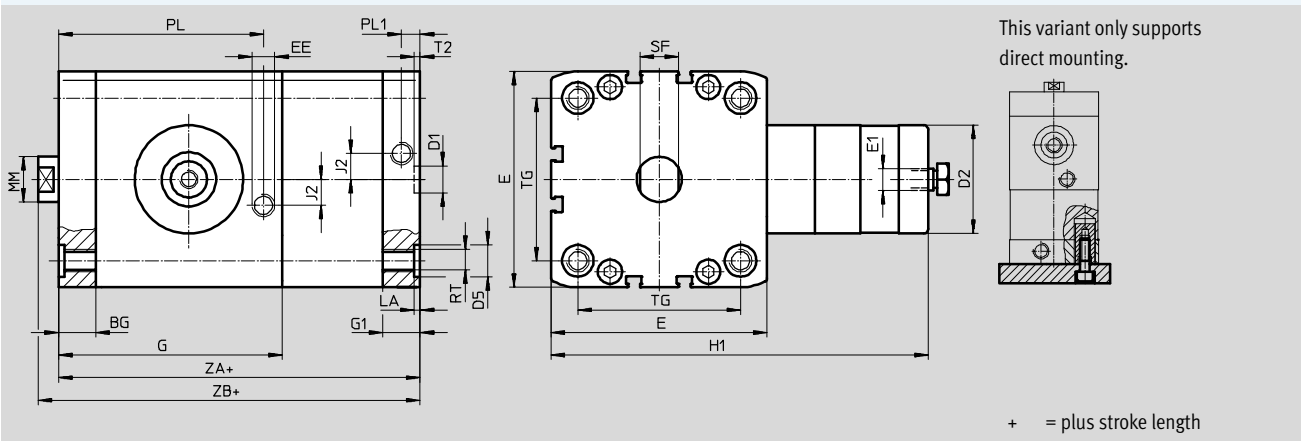

∅	BG	D1	D2	D5	E	E1	EE	G	G1	H1	J2
[mm]	min.	∅ H9	∅	∅							
20	19.5	9	20	9F9	35.5 ^{+0.3}	M5	M5	49.8	12	63	2.6
25					39.5 ^{+0.3}			50.6		65	
32					47 ^{+0.3}			56.4		68	
40	26	12	24	12F9	54.5 ^{+0.3}	G1/8	G1/8	60.4	89	8	
50			30		65.5 ^{+0.3}			67.4	108		
63			38		75.5 ^{+0.3}			76.8	120		
80	17	12	48	15	95.5 ^{+0.6}	G1/8	G1/8	99	16.5	167	11.5
100	21.5				113.5 ^{+0.6}			99.6	21.5	176	

∅	LA	MM	PL	PL1	RT	SF	T2	TG	ZA	ZB
[mm]	+0.2	∅	+0.2	+0.2		h13	+0.2	±0.2	±0.3	+1.2
20	5	10	42.8	6	M5	9	2.1	22	74.8	80.8
25			44.6					26	77.6	83.1
32			49.6					32.5	85.4	91.4
40		16	53.6	38	90.4	96.5				
50		20	8.2	60.6	M8	17	2.6	46.5	97.4	105.6
63				70				56.5	110.8	118.9
80	90.7			72				136.5	145.4	
100	2.6	25	88.6	10.5	M10	21	89	145.1	154.1	

Compact cylinders ADN-KP, standard port pattern, with clamping unit

Technical data

Dimensions – Variants

Download CAD data → www.festo.com

Basic version

1 Hex nut to DIN 439-B only with \varnothing 32 ... 100

+ = plus stroke length

K2 – Extended male piston rod thread

1 Hex nut to DIN 439-B only with \varnothing 32 ... 100

+ = plus stroke length

K5 – Special piston rod thread

1 Hex nut to DIN 439-B only with \varnothing 32 ... 100

+ = plus stroke length

K8 – Extended piston rod

1 Hex nut to DIN 439-B only with \varnothing 32 ... 100

+ = plus stroke length

Compact cylinders ADN-KP, standard port pattern, with clamping unit

Technical data

∅ [mm]	A	A1	A2	AF	AF5	KF	KF5
	-0.5			min.	min.		
20	16	1 ... 20	1 ... 300	14	12	M6	M5
25							
32	19		1 ... 400	16	14	M8	M6
40							
50	22	1 ... 30	1 ... 500	20	16	M10	M8
63							
80	28				20	M12	M10
100							

∅ [mm]	KK	KK5	T3	T4	WH +1.3	ZB +1.2
20	M8	M10x1.25	2	2.6	5.5	80.8
25		M10				83.1
32	M10x1.25	M10	2.6	3.3	6	91.4
40		M12				96.5
50	M12x1.25	M12	3.3	4.7	8.2	105.6
63		M16				118.9
80	M16x1.5	M16	4.7	6.1	8.9	145.4
100		M20x1.5 M20				9

Compact cylinders ADN-KP, standard port pattern, with clamping unit



Ordering data – Modular products

Ordering table							
Size	20	25	32	40	Condi- tions	Code	Enter code
M Module No.	548206	548207	548208	548209			
Function	Compact cylinder, double-acting, standard port pattern, with clamping unit					ADN	ADN
Piston Ø [mm]	20	25	32	40		-...	
Stroke [mm]	10 ... 300		10 ... 400			-...	
Clamping unit	Integrated					-KP	-KP
Piston rod thread	Male thread					-A	
	Female thread				1	-I	
Cushioning	Flexible cushioning rings/pads at both ends					-P	-P
Position sensing	Via proximity sensor					-A	-A
O Male thread extended [mm]	Extended male piston rod thread 1 ... 20					-...K2	
Special piston rod thread	Male thread	M10x1.25 M10	M10x1.25 M10	M10 M12	M10 M12	-“...”K5	
	Female thread	M5	M5	M6	M6		
Piston rod extended [mm]	Extended piston rod 1 ... 300		1 ... 400		2	-...K8	
Captive rating plate	Laser etched rating plate					-TL	

- 1** I Not with extended male thread K2
- 2** K8 The sum of the stroke length and piston rod extension must not exceed the maximum permissible stroke length

- M** Mandatory data
- O** Options

Transfer order code

Compact cylinders ADN-KP, standard port pattern, with clamping unit

Ordering data – Modular products

Ordering table							
Size	50	63	80	100	Condi- tions	Code	Enter code
M Module No.	548210	548211	548212	548213			
Function	Compact cylinder, double-acting, standard port pattern, with clamping unit					ADN	ADN
Piston Ø [mm]	50	63	80	100		-...	
Stroke [mm]	10 ... 400		10 ... 500			-...	
Clamping unit	Integrated					-KP	-KP
Piston rod thread	Male thread					-A	
	Female thread				1	-I	
Cushioning	Flexible cushioning rings/pads at both ends					-P	-P
Position sensing	Via proximity sensor					-A	-A
O Male thread extended [mm]	Extended male piston rod thread 1 ... 20		1 ... 30			-...K2	
Special piston rod thread	Male thread	M12 M16	M12 M16	M16 M20 M20x1.5	M16 M20 M20x1.5	-“...”K5	
	Female thread	M8	M8	M10	M10		
Piston rod extended [mm]	Extended piston rod 1 ... 400		1 ... 500		2	-...K8	
Captive rating plate	Laser etched rating plate					-TL	

- 1 I** Not with extended male thread K2
- 2 K8** The sum of the stroke length and piston rod extension must not exceed the maximum permissible stroke length

- M** Mandatory data
- O** Options

Transfer order code

- - - -

Compact cylinders ADN-EL, standard port pattern, with end position lock

Type codes

ADN – 20 – 100 – ELV – A – P – A – K2

Type	
Double-acting	
ADN	Compact cylinder
Piston Ø [mm]	
Stroke [mm]	
End position lock	
ELB	At both ends
ELV	At front
ELH	At rear
Piston rod thread	
A	Male thread
I	Female thread
Cushioning	
P	Flexible cushioning rings/pads at both ends
Position sensing	
A	Via proximity sensor
Variant	
K2	Extended male piston rod thread
K5	Special piston rod thread
K8	Extended piston rod
TL	Captive rating plate

Compact cylinders ADN-EL, standard port pattern, with end position lock

Technical data

Function

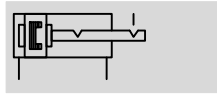

- \varnothing - Diameter
20 ... 100 mm

- | - Stroke length
10 ... 500 mm

Variants



K2

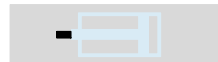

K5

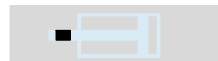

K8



Note

Additional measures are required for use in safety-related control systems; in Europe, for example, the standards listed under the EC Machinery Directive must be observed. Without

additional measures in accordance with statutory minimum requirements, the product is not suitable for use in safety-related sections of control systems.

General technical data								
Piston \varnothing	20	25	32	40	50	63	80	100
Pneumatic connection	M5	M5	G1/8	G1/8	G1/8	G1/8	G1/8	G1/8
Female piston rod thread								
-	M6		M8		M10		M12	
K5	M5		M6		M8		M10	
Male piston rod thread								
-	M8		M10x1.25		M12x1.25		M16x1.5	
K5	M10; M10x1.25		M10; M12		M12; M16		M16; M20; M20x1.5	
Max. axial backlash with end position locked [mm]	1.3						2.1	
Constructional design								
	Piston							
	Piston rod							
	Cylinder barrel							
End position lock								
ELB	At both ends							
ELV	At front							
ELH	At rear							
Cushioning	Flexible cushioning rings/pads at both ends							
Position sensing	Via proximity sensor							
Type of mounting								
	Via female threads							
	Via accessories							
Mounting position	Any							

- - Note

- No screws with a head or similar may be used in place of the end position lock, as there is a risk that the function will be impaired if they are screwed in too deeply.
- The exhaust hole must not be closed.
- Locking can be performed from any stroke position, once the drive is brought mechanically into its end position.
- The end position lock has been designed to guard against the load dropping in case of pressure failure.
- Operation of the cylinder in conjunction with a 3-way valve (especially with the function “mid-position closed” and those with “metallic sealing”) should be avoided. The residual pressure that is enclosed on the locking side of the cylinder can release the locking function.
- The cylinder must not be operated with external stops (e.g. shock absorber, buffer, oil brake, etc.):
- It may not be possible to reliably reach the internal end position.
- The locking mechanism can wear out prematurely. (In the event of pressure drop in the opposite chamber to less than the locking pressure, the locking piston will prematurely fall to its end position.)

Compact cylinders ADN-EL, standard port pattern, with end position lock

Technical data



Operating and environmental conditions								
Piston Ø	20	25	32	40	50	63	80	100
Operating medium	Compressed air in accordance with ISO 8573-1:2010 [7:4:4]							
Note on operating/pilot medium	Operation with lubricated medium possible (in which case lubricated operation will always be required)							
Operating pressure [bar]	2.5 ... 10				1.5 ... 10			
Ambient temperature ¹⁾ [°C]	-20 ... +80							
Corrosion resistance class CRC ²⁾	2							

1) Note operating range of proximity sensors

2) Corrosion resistance class CRC 2 to Festo standard FN 940070

Moderate corrosion stress. Indoor applications in which condensation may occur. External visible parts with primarily decorative requirements for the surface and which are in direct contact with the ambient atmosphere typical for industrial applications.

Forces [N]								
Piston Ø	20	25	32	40	50	63	80	100
Theoretical force at 6 bar, advancing	188	295	483	754	1178	1870	3016	4712
Theoretical force at 6 bar, retracting	141	247	415	686	1057	1750	2827	4524
Static holding force	250	500			2000		5000	

Sizing example

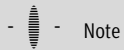

Note
When sizing pneumatic cylinders it is recommended as a basic principle that only 50% of the indicated theoretical forces (see above) be used.

Given:

Installation position = Vertical

Workpiece load = 44 kg

$$F = m \times g = 44 \text{ kg} \times 9.81 \text{ m/s}^2 = 431.6 \text{ N}$$

To be calculated:

Suitable piston Ø

Analysis with 32 mm piston Ø:

Theoretical force at 6 bar, advancing = 483 N

50% of the theoretical force = 241.5 N

Static holding force with 32 mm piston Ø = 500 N

The static force on the end position lock is within the permissible range (max. 500 N) with a workpiece load of 44 kg (431.6 N), however the cylinder would be at 89% capacity.

Result:

A cylinder with a piston Ø of 40 mm is therefore recommended for this application.

Impact energy [J]								
Piston Ø	20	25	32	40	50	63	80	100
Max. impact energy at the end positions	0.2	0.3	0.4	0.7	1	1.3	1.8	2.5

Permissible impact velocity:

$$v_{\text{perm.}} = \sqrt{\frac{2 \times E_{\text{perm.}}}{m_{\text{dead}} + m_{\text{load}}}}$$

$v_{\text{perm.}}$ Permissible impact velocity

$E_{\text{perm.}}$ Max. impact energy

m_{dead} Moving load (drive)

m_{load} Moving work load



Note
These specifications represent the maximum values which can be reached. Note the maximum permitted impact energy.

Maximum permissible load:

$$m_{\text{load}} = \frac{2 \times E_{\text{perm.}}}{v^2} - m_{\text{dead}}$$

Max. lateral force F_q as a function of the projection x

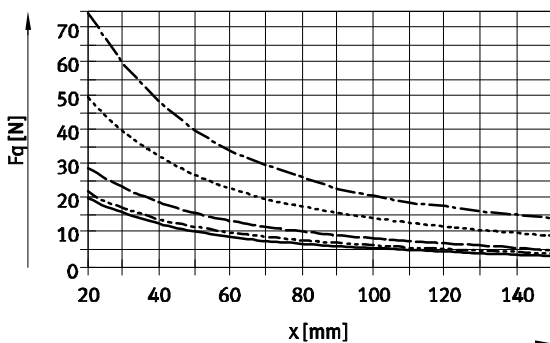

- Ø 20
- - - - - Ø 25
- · - · - · Ø 32/40
- · · · · Ø 50/63
- - - - - Ø 80/100

Compact cylinders ADN-EL, standard port pattern, with end position lock

Technical data

Weight [g]								
Piston \varnothing	20	25	32	40	50	63	80	100
End position lock at both ends								
Product weight with 0 mm stroke	234	339	518	665	1334	1734	3300	4735
Additional weight per 10 mm stroke	22	26	29	38	51	59	79	98
Moving load with 0 mm stroke	43	53	85	101	199	248	475	637
Additional load per 10 mm stroke	6	6	9	9	16	16	25	25
End position lock at front								
Product weight with 0 mm stroke	177	248	387	498	922	1228	2296	3448
Additional weight per 10 mm stroke	22	26	29	38	51	59	79	98
Moving load with 0 mm stroke	35	46	75	98	175	225	464	626
Additional load per 10 mm stroke	6	6	9	9	16	16	25	25
End position lock at rear								
Product weight with 0 mm stroke	181	252	380	505	920	1217	2233	3409
Additional weight per 10 mm stroke	22	26	29	38	51	59	79	98
Moving load with 0 mm stroke	37	45	73	89	168	217	413	582
Additional load per 10 mm stroke	6	6	9	9	16	16	25	25

Materials

Sectional view

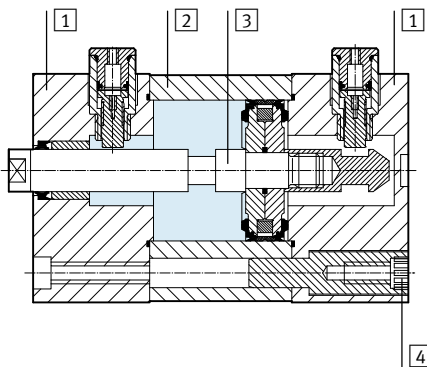

Compact cylinder		
1	Cover	Anodised aluminium
2	Cylinder barrel	Anodised aluminium
3	Piston rod	High-alloy steel
4	Flange screws	\varnothing 20 ... 63
		\varnothing 80 ... 100
-	Seals	Polyurethane, nitrile rubber
-	Note on materials	RoHS compliant

Compact cylinders ADN-EL, standard port pattern, with end position lock

Technical data



Dimensions – Basic version

Download CAD data → www.festo.com

ELB – End position lock at both ends

Ø 20 ... 63

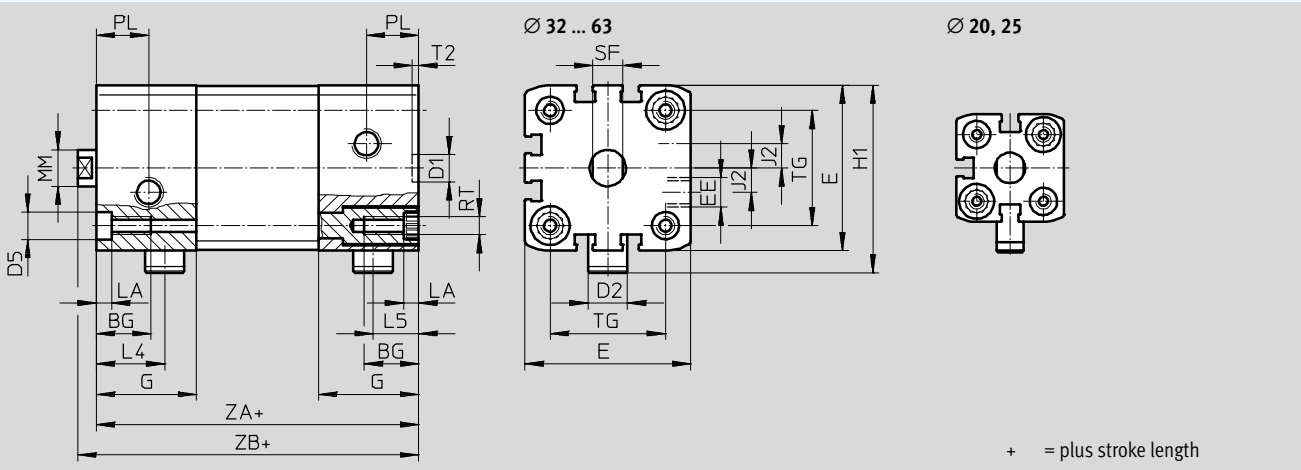

Ø 80 ... 100

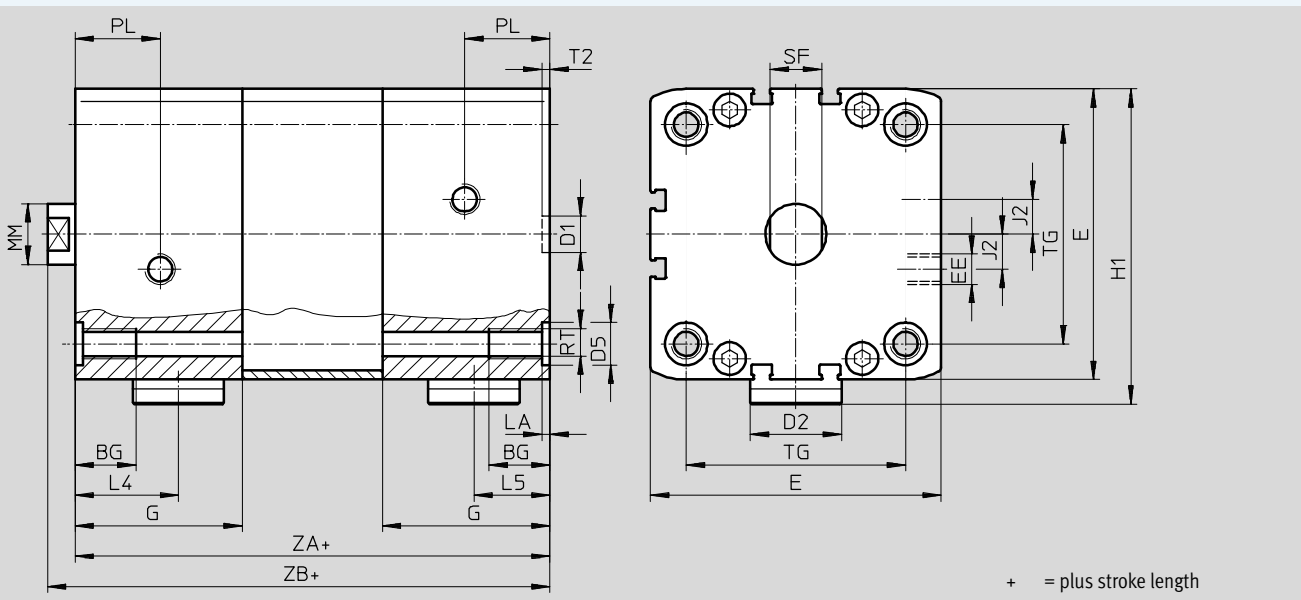

ELV – End position lock at front

ELH – End position lock at rear

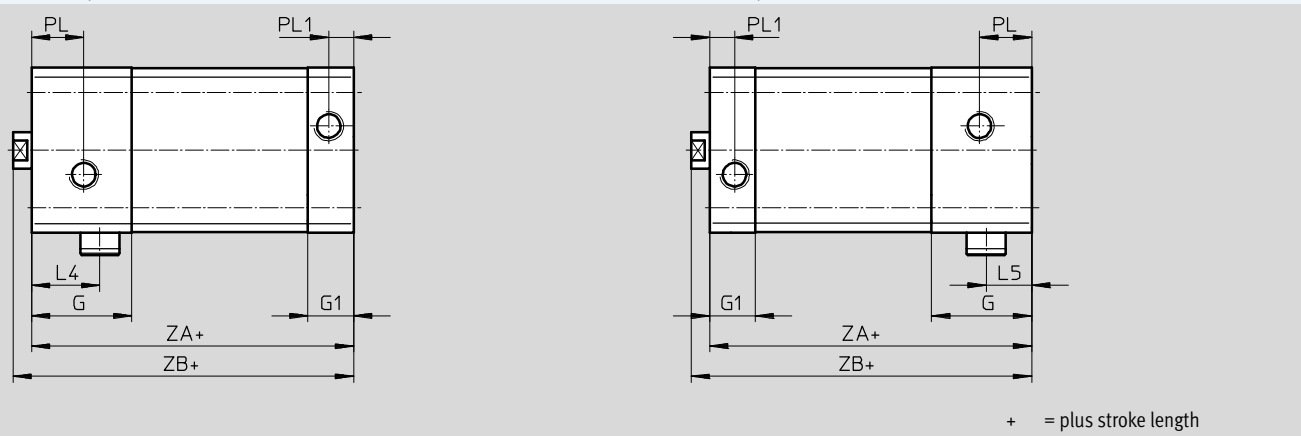

Compact cylinders ADN-EL, standard port pattern, with end position lock



Technical data

∅ [mm]	BG min.	D1 ∅ H9	D2 ∅	D5 ∅	E	EE	G	G1	H1	J2	L4	L5	
20	18	9	9	9 ^{F9}	35.5 ^{+0.3}	M5	25	12	45.5	2.6	18.5	12.5	
25			13		39.5 ^{+0.3}		29.5		53.3		20.8	14	
32					20	12	47 ^{+0.3}	G1/8	33	15	58	6	22.5
40			20				12				54.5 ^{+0.3}	43	8
50	30	15		65.5 ^{+0.3}	55	11.5			77	11.5	34		
63			75.5 ^{+0.3}	16.5			82		25				
80	20	12	30	15	95.5 ^{+0.6}	57	21.5	103.5	20	35	27		
100					113.5 ^{+0.6}		21.5	113.5	20	35	27		

∅ [mm]	LA +0.2	MM ∅	PL	PL1	RT	SF h13	T2 +0.1	TG ±0.2	ZA ±0.3		ZB +1.2							
									ELB	ELV, ELH	ELB	ELV, ELH						
20	5	10	6	6	M5	9	2.1	22	63	50	68.8	55.5						
25									12	16	8.2	M6	10	2.6	26	56.5	79.5	62
32															16	21	M8	13
40									20	12	10.5	M10	17	2.6				
50	20	12	10.5	M10	17	2.6	46.5	73							109.2	81.2		
63							20	12	10.5	M10	17	2.6	56.5	77	113.1	85.1		
80	20	12	10.5	M10	17	2.6							72	92.5	139.9	101.4		
100							20	12	10.5	M10	17	2.6	89	102.5	147	111.5		

Compact cylinders ADN-EL, standard port pattern, with end position lock

FESTO

Technical data

Dimensions – Variants

Download CAD data → www.festo.com

Basic version

1 Hex nut to DIN 439-B only with \varnothing 32 ... 100

+ = plus stroke length

K2 – Extended male piston rod thread

1 Hex nut to DIN 439-B only with \varnothing 32 ... 100

+ = plus stroke length

K5 – Special piston rod thread

+ = plus stroke length

K8 – Extended piston rod

1 Hex nut to DIN 439-B only with \varnothing 32 ... 100

+ = plus stroke length

Compact cylinders ADN-EL, standard port pattern, with end position lock

Technical data

∅ [mm]	A	A1	A2	AF	AF5	KF	KF5	
	-0.5			min.	min.			
20	16	1 ... 20	1 ... 300	14	12	M6	M5	
25				16	14	M8	M6	
32	19		1 ... 400	20	16	14	M10	M8
40					20	16	M12	M10
50	22							
63	28	1 ... 30	1 ... 500	20	20	M12	M10	
80								
100								

∅ [mm]	KK	KK5	T3	T4	WH +1.3	ZB +1.2	
						ELB	ELV. ELH
20	M8	M10x1.25	2	2.6	5.5	68.8	55.5
25		M10				79.5	62
32	M10x1.25	M10	2.6	3.3	6	86	68
40		M12				87.1	69
50	M12x1.25	M12	3.3	4.7	8.2	109.2	81.2
63		M16				113.1	85.1
80	M16x1.5	M16	4.7	6.1	8.9	139.9	101.4
100		M20x1.5 M20				147	111.5

Compact cylinders ADN-EL, standard port pattern, with end position lock



Ordering data – Modular products

Ordering table							
Size	20	25	32	40	Condi- tions	Code	Enter code
M Module No.	548214	548215	548216	548217			
Function	Compact cylinder, double-acting, standard port pattern, with end position lock					ADN	ADN
Piston Ø [mm]	20	25	32	40		-...	
Stroke [mm]	10 ... 300		10 ... 400			-...	
End position lock	At both ends					-ELB	
	At front					-ELV	
	At rear					-ELH	
Piston rod thread	Male thread					-A	
	Female thread				1	-I	
Cushioning	Flexible cushioning rings/pads at both ends					-P	-P
Position sensing	Via proximity sensor					-A	-A
O Male thread extended [mm]	Extended male piston rod thread 1 ... 20					-...K2	
Special piston rod thread	Male thread	M10x1.25 M10	M10x1.25 M10	M10 M12	M10 M12	-“...”K5	
	Female thread	M5	M5	M6	M6		
Piston rod extended [mm]	Extended piston rod 1 ... 300		1 ... 400		2	-...K8	
Captive rating plate	Laser etched rating plate					-TL	

- 1** I Not with extended male thread K2
- 2** K8 The sum of the stroke length and piston rod extension must not exceed the maximum permissible stroke length

- M** Mandatory data
- O** Options

Transfer order code

Compact cylinders ADN-EL, standard port pattern, with end position lock



Ordering data – Modular products

Ordering table							
Size	50	63	80	100	Condi- tions	Code	Enter code
M Module No.	548218	548219	548220	548221			
Function	Compact cylinder, double-acting, standard port pattern, with end position lock					ADN	ADN
Piston Ø [mm]	50	63	80	100		-...	
Stroke [mm]	10 ... 400		10 ... 500			-...	
End position lock	At both ends					-ELB	
	At front					-ELV	
	At rear					-ELH	
Piston rod thread	Male thread					-A	
	Female thread				¹	-I	
Cushioning	Flexible cushioning rings/pads at both ends					-P	-P
Position sensing	Via proximity sensor					-A	-A
O Male thread extended [mm]	Extended male piston rod thread 1 ... 20		1 ... 30			-...K2	
Special piston rod thread	Male thread	M12 M16	M12 M16	M16 M20 M20x1.5	M16 M20 M20x1.5	-“...”K5	
	Female thread	M8	M8	M10	M10		
Piston rod extended [mm]	Extended piston rod 1 ... 400		1 ... 500		²	-...K8	
Captive rating plate	Laser etched rating plate					-TL	

- ¹ **I** Not with extended male thread K2
- ² **K8** The sum of the stroke length and piston rod extension must not exceed the maximum permissible stroke length

- M** Mandatory data
- O** Options

Transfer order code

- - - -

Compact cylinders AEN, to ISO 21287

Type codes

AEN – 50 – 25 – A – P – A – Q

Type

Single-acting	
AEN	Compact cylinder

Piston Ø [mm]

Stroke [mm]

Piston rod thread

A	Male thread
I	Female thread

Cushioning

P	Flexible cushioning rings/pads at both ends
---	---

Position sensing

A	Via proximity sensor
---	----------------------

Variant

Z	Single-acting, pulling
Q	Square piston rod
K2	Extended male piston rod thread
K5	Special piston rod thread
K8	Extended piston rod
K10	Smooth anodised piston rod
S6	Heat-resistant seals up to max. 120 °C
TL	Captive rating plate

Compact cylinders AEN, to ISO 21287

Technical data

Function

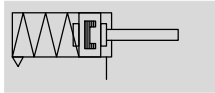

pulling

⊘ - Diameter
12 ... 100 mm

— | — Stroke length
1 ... 25 mm

- www.festo.com

Variants



S6



K2



K5



K8

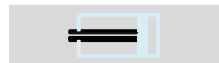

K10

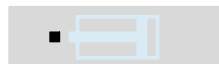

Q

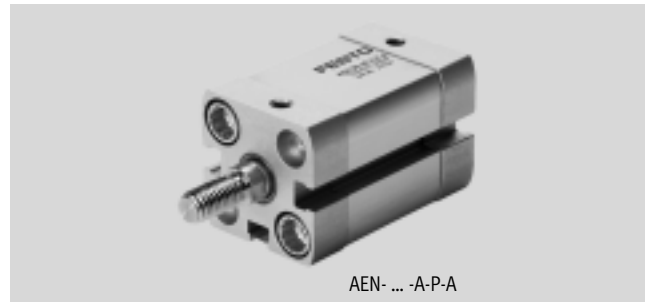

AEN- ... -A-P-A

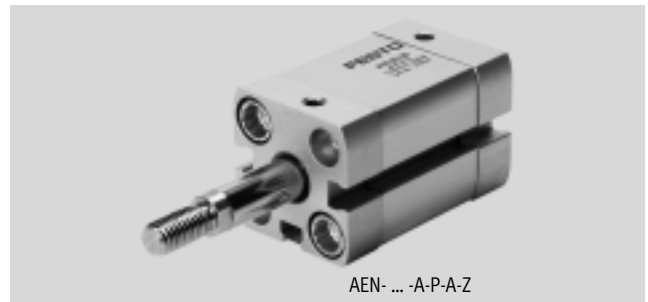

AEN- ... -A-P-A-Z

General technical data

Piston Ø	12	16	20	25	32	40	50	63	80	100
Design	Piston									
	Piston rod									
	Cylinder barrel									
Cushioning	Flexible cushioning rings/pads at both ends									
Position sensing	Via proximity sensor									
Type of mounting	Via through-hole									
	Via female thread									
	Via accessories									
Mounting position	Any									

Technical data – Basic version and variants

Piston Ø	12	16	20	25	32
Pneumatic connection	M5	M5	M5	M5	G1/8
Female piston rod thread					
—	M3	M4	M6	M6	M8
K5	—	—	M5	M5	M6
Male piston rod thread					
—	M5	M6	M8	M8	M10x1.25
K5	M6	M8	M10; M10x1.25	M10; M10x1.25	M10; M12
Q-K5	—	M8	M10; M10x1.25	M10; M10x1.25	M10

Piston Ø	40	50	63	80	100
Pneumatic connection	G1/8	G1/8	G1/8	G1/8	G1/8
Female piston rod thread					
—	M8	M10	M10	M12	M12
K5	M6	M8	M8	M10	M10
Male piston rod thread					
—	M10x1.25	M12x1.25	M12x1.25	M16x1.5	M16x1.5
K5	M10; M12	M12; M16	M12; M16	M16; M20; M20x1.5	M16; M20; M20x1.5
Q-K5	M10	M12	M12	M16	M16

Compact cylinders AEN, to ISO 21287

Technical data

FESTO

Operating and environmental conditions										
Piston Ø	12	16	20	25	32	40	50	63	80	100
Operating medium	Compressed air in accordance with ISO 8573-1:2010 [7:4:4]									
Note on operating/pilot medium	Operation with lubricated medium possible (in which case lubricated operation will always be required)									
Operating pressure [bar]										
-	1.5 ... 10		1 ... 10							
Z	1.7 ... 10	2.2 ... 10	1.3 ... 10			0.7 ... 10	0.6 ... 10			
Q	1.5 ... 10		1 ... 10							
Ambient temperature ¹⁾ [°C]										
-	-20 ... +80									
S6	0 ... +120									
Corrosion resistance class CRC ²⁾	2									

1) Note operating range of proximity sensors

2) Corrosion resistance class CRC 2 to Festo standard FN 940070

Moderate corrosion stress. Indoor applications in which condensation may occur. External visible parts with primarily decorative requirements for the surface and which are in direct contact with the ambient atmosphere typical for industrial applications.

Forces [N] and impact energy [J]										
Piston Ø	12	16	20	25	32	40	50	63	80	100
AEN										
Theoretical force at 6 bar, advancing	56	95	162	259	441	702	1098	1783	2899	4511
AEN...Z, pulling										
Theoretical force at 6 bar, retracting	39	65	115	211	373	634	977	1663	2610	4323
Max. impact energy in the end positions	0.04	0.04	0.04	0.08	0.1	0.15	0.18	0.28	0.35	0.7

Permissible impact velocity:
$$v_{perm.} = \sqrt{\frac{2 \times E_{perm.}}{m_{dead} + m_{load}}}$$

$v_{perm.}$ Permissible impact velocity
 $E_{perm.}$ Max. impact energy
 m_{dead} Moving load (drive)
 m_{load} Moving effective load

Note
 This data represents the maximum values that can be achieved. The maximum permissible impact energy must be observed.

Maximum permissible load:
$$m_{load} = \frac{2 \times E_{perm.}}{v^2} - m_{dead}$$

Spring return force F as a function of the stroke l

Ø 12 ... 20

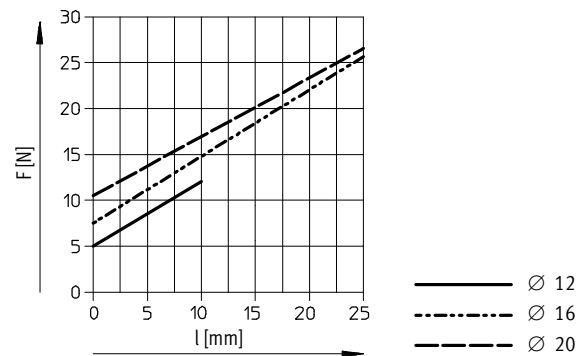

Ø 25 ... 100

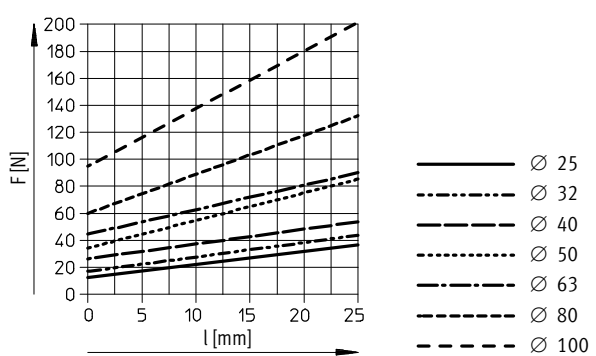

Note
 The degree of friction depends upon the mounting position and the type of load involved. Single-acting cylinders should as far as possible be operated without lateral forces.

Compact cylinders AEN, to ISO 21287

Technical data

Weight [g]										
Piston \varnothing	12	16	20	25	32	40	50	63	80	100
Product weight with 0 mm stroke	77	79	131	156	265	346	540	722	1300	2154
Additional weight per 10 mm stroke	12	14	21	23	30	37	51	59	79	98
Moving load with 0 mm stroke	9	15	30	50	60	80	140	180	400	570
Additional load per 10 mm stroke	2	4	6	6	9	9	16	16	25	25

Materials

Sectional view

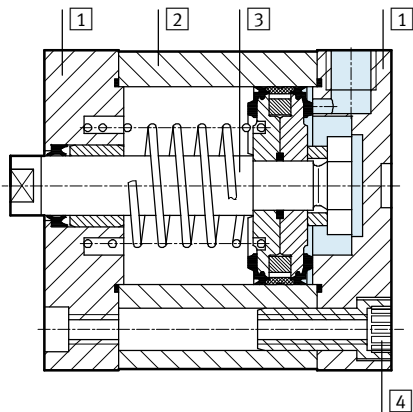

Compact cylinder	Basic version	S6
1 Bearing and end cap	\varnothing 12 ... 80	Anodised aluminium
	\varnothing 100	Coated die-cast aluminium
2 Cylinder barrel		Anodised aluminium
3 Piston rod		High-alloy steel
4 Flange screws	\varnothing 12 ... 16	High-alloy steel
	\varnothing 20 ... 63	Galvanised steel
	\varnothing 80 ... 100	Standard screws, galvanised steel
- Seals	Polyurethane	Fluoro elastomer
Note on materials	RoHS-compliant	

Compact cylinders AEN, to ISO 21287

Technical data



Dimensions – Basic version

Download CAD data → www.festo.com

Ø 12 ... 63

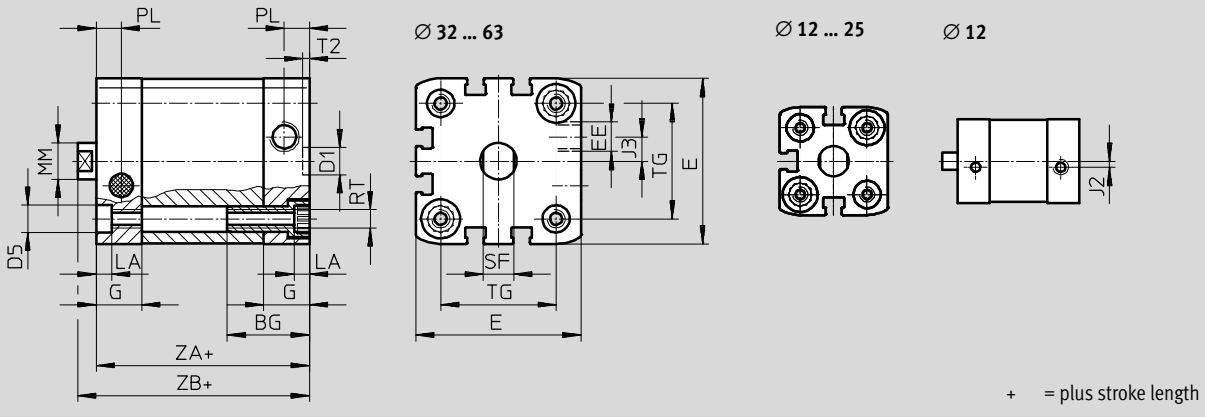

Ø 80 ... 100

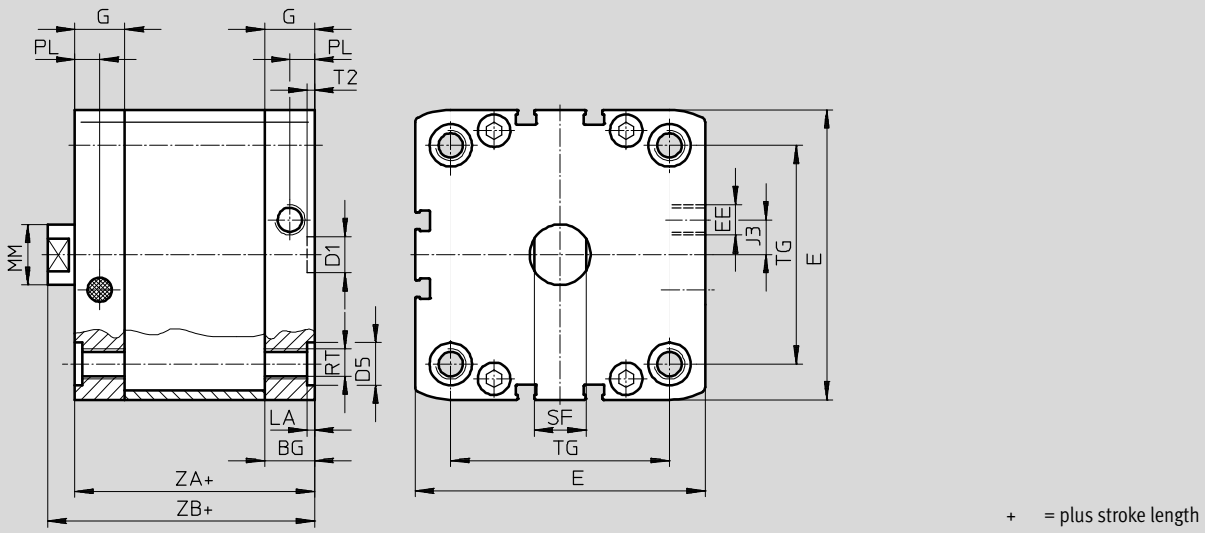

Compact cylinders AEN, to ISO 21287

Technical data

∅ [mm]	BG min.	D1 ∅ H9	D5 ∅	E	EE	G	J2	J3	LA +0.2
12	17	9	6 ^{F9}	27.5 ^{+0.3}	M5	10.5	2	-	3.5
16				29 ^{+0.3}		11			
20	19.5		9 ^{F9}	35.5 ^{+0.3}		12	2.6		
25				39.5 ^{+0.3}					
32	26		12	12 ^{F9}	47 ^{+0.3}	G1/8	15	6	5
40					54.5 ^{+0.3}				
50	27	12 ^{F9}		65.5 ^{+0.3}	16.5		11.5		
63				75.5 ^{+0.3}					
80	17	15	95.5 ^{+0.6}	21.5	20	2.6			
100	21.5		113.5 ^{+0.6}						

∅ [mm]	MM ∅	PL +0.2	RT	SF h13	T2 +0.1	TG ±0.2	ZA ±0.3	ZB +1.2
12	6	6	M4	5	2.1	16	35	39.2
16	8			7		18		39.7
20	10		M5	9		22	37	42.5
25						26	39	44.5
32	12	8.2	M6	10	32.5	44	50	
40					38		51.1	
50	16		M8	13	46.5	45	53.2	
63					56.5		49	57.1
80	20	10.5	M10	17	72	54	62.9	
100					89		67	76

Compact cylinders AEN, to ISO 21287

Technical data

FESTO

Dimensions – Variants

Download CAD data → www.festo.com

Basic version

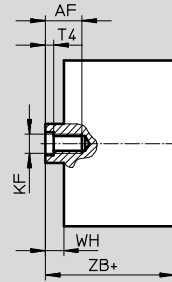
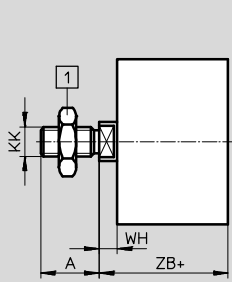

1 Hex nut DIN 439-B
only with \varnothing 32 ... 100

+ = plus stroke length

Z – pulling

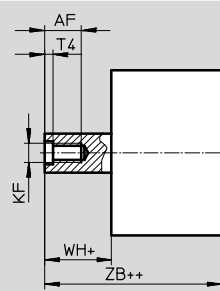
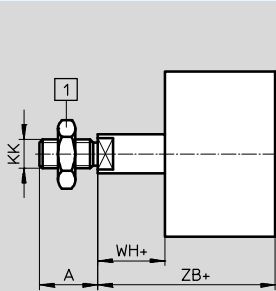

1 Hex nut DIN 439-B
only with \varnothing 32 ... 100

+ = plus stroke length

++ = plus 2x stroke length

K2 – Extended male piston rod thread

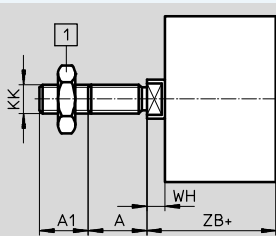

1 Hex nut DIN 439-B
only with \varnothing 32 ... 100

+ = plus stroke length

K5 – Special piston rod thread

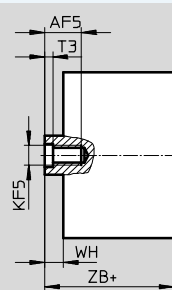
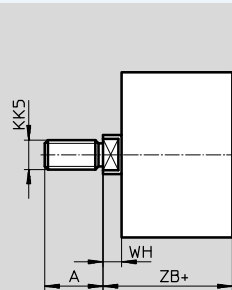

+ = plus stroke length

K8 – Extended piston rod

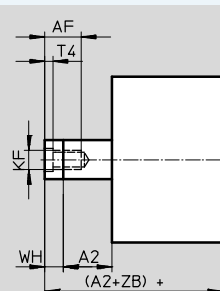
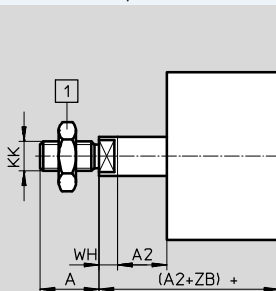

1 Hex nut DIN 439-B
only with \varnothing 32 ... 100

+ = plus stroke length

Compact cylinders AEN, to ISO 21287

Technical data



∅ [mm]	A -0.5	A1	A2	AF min.	AF5 min.	KF	KF5
12	10	1 ... 10	1 ... 300	8	-	M3	-
16	12			10		M4	
20	16	1 ... 20		14	12	M6	M5
25			19	16	14	M8	M6
32	22			20	16	M10	M8
40			1 ... 30			1 ... 500	20
50							
63							
80	28						
100							

∅ [mm]	KK	KK5	T3	T4	WH +1.3	ZB +1.2
12	M5	M6	-	1.5	4.2	39.2
16	M6	M8			4.7	39.7
20	M8	M10x1.25	2	2.6	5.5	42.5
25		M10				44.5
32	M10x1.25	M10	2.6	3.3	6	50
40		M12			6.1	51.1
50	M12x1.25	M12	3.3	4.7	8.2	53.2
63		M16			8.1	57.1
80	M16x1.5	M16	4.7	6.1	8.9	62.9
100		M20x1.5 M20			9	76

Compact cylinders AEN, to ISO 21287

Technical data

FESTO

Dimensions – Variants

Download CAD data → www.festo.com

Q – Square piston rod

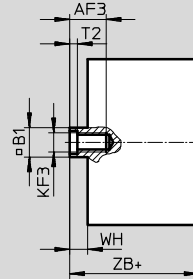
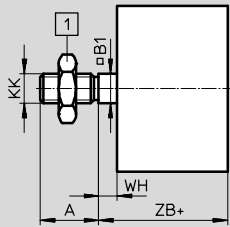

1 Hex nut DIN 439-B
only with $\varnothing 32 \dots 100$

+ = plus stroke length

Q – Z – pulling

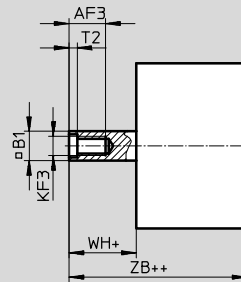
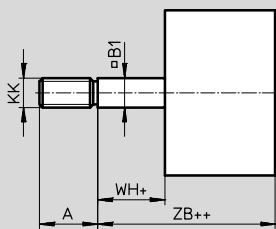

1 Hex nut DIN 439-B
only with $\varnothing 32 \dots 100$

+ = plus stroke length

++ = plus 2x stroke length

Q-K2 – Square piston rod with extended male thread

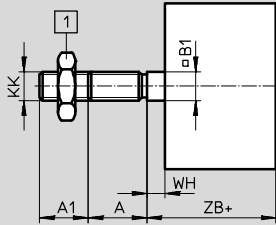

1 Hex nut DIN 439-B
only with $\varnothing 32 \dots 100$

+ = plus stroke length

Q-K5 – Square, special piston rod thread

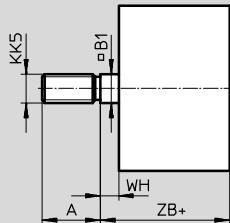

+ = plus stroke length

Q-K8 – Square, extended piston rod

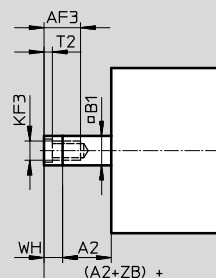
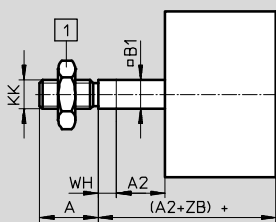

1 Hex nut DIN 439-B
only with $\varnothing 32 \dots 100$

+ = plus stroke length

Compact cylinders AEN, to ISO 21287

Technical data

FESTO

∅ [mm]	A -0.5	A1 1 ... 10	A2 1 ... 300	AF3 min.	B1 □ 7	KF3 M4
16	12	1 ... 20	1 ... 300	10	7	M4
20	16			12	9	M5
25	19	1 ... 20	1 ... 400	14	10	M6
32				16	12	M8
40	22	1 ... 30	1 ... 500	16	12	M8
50				20	16	M10
63	28	1 ... 30	1 ... 500	20	16	M10
80				20	16	M10
100	28	1 ... 30	1 ... 500	20	16	M10

∅ [mm]	KK M6	KK5 M8	T2 1.5	WH +1.3 4.7	ZB +1.2 39.7
16	M6	M8	1.5	4.7	39.7
20	M8	M10x1.25	2	5.5	42.5
25		M10			44.5
32	M10x1.25	M10	2.6	6	50
40				6.1	51.1
50	M12x1.25	M12	3.3	8.2	53.2
63				8.1	57.1
80	M16x1.5	M16	4.7	8.9	62.9
100				9	76

Compact cylinders AEN, to ISO 21287

Ordering data – Modular products, basic version and variants

Ordering table									
Size	12	16	20	25	32	Condi- tions	Code	Enter code	
M Module No.	536414	536415	536416	536417	536418				
Function	Compact cylinder, single-acting, based on ISO 21287							AEN	AEN
Piston Ø [mm]	12	16	20	25	32		-...		
Stroke [mm]	1 ... 10	1 ... 25					-...		
Type of thread	Male thread						-A		
	Female thread					1	-I		
Cushioning	Flexible cushioning rings/pads at both ends						-P	-P	
Position sensing	Via proximity sensor						-A	-A	
O Effective direction of action	Single-acting, pulling						-Z		
Male thread extended [mm]	Extended male piston rod thread 1 ... 10		1 ... 20			2	-...K2		
Special piston rod thread	Male thread	M6	M8	M10x1.25 M10	M10x1.25 M10	M10 M12	2	-“...”K5	
	Female thread	-	-	M5	M5	M6			
Piston rod extended [mm]	Extended piston rod 1 ... 10		1 ... 25				-...K8		
Improved running performance	-		Smooth anodised aluminium coated piston rod				-K10		
Temperature resistance	Heat-resistant seals up to max. 120 °C						-S6		
Captive rating plate	Laser etched rating plate						-TL		

- 1 I** Not with extended male thread K2
- 2 K2, K5** Not with improved running performance K10

- M** Mandatory data
- O** Options

Transfer order code

AEN - - - - **P** - **A**

Compact cylinders AEN, to ISO 21287

Ordering data – Modular products, basic version and variants

Ordering table								
Size	40	50	63	80	100	Condi- tions	Code	Enter code
M Module No.	536419	536420	536421	536422	536423			
Function	Compact cylinder, single-acting, based on ISO 21287						AEN	AEN
Piston Ø [mm]	40	50	63	80	100		-...	
Stroke [mm]	1 ... 25						-...	
Type of thread	Male thread						-A	
	Female thread					1	-I	
Cushioning	Flexible cushioning rings/pads at both ends						-P	-P
Position sensing	Via proximity sensor						-A	-A
O Effective direction of action	Single-acting, pulling						-Z	
Male thread extended [mm]	Extended male piston rod thread 1 ... 20			1 ... 30		2	-...K2	
Special piston rod thread	Male thread	M10	M12	M12	M16	M16	2	-“...”K5
		M12	M16	M16	M20	M20		
	Female thread	M6	M8	M8	M10	M10		
Piston rod extended [mm]	Extended piston rod 1 ... 25						-...K8	
Improved running performance	Smooth anodised aluminium coated piston rod						-K10	
Temperature resistance	Heat-resistant seals up to max. 120 °C						-S6	
Captive rating plate	Laser etched rating plate						-TL	

- 1 I** Not with extended male thread K2
- 2 K2, K5** Not with improved running performance K10

- M** Mandatory data
- O** Options

Transfer order code

- - - - - - -

Compact cylinders AEN, to ISO 21287

Ordering data – Modular products, Q – Version with square piston rod, non-rotating

Ordering table							
Size	16	20	25	32	Condi- tions	Code	Enter code
M Module No.	536415	536416	536417	536418			
Function	Compact cylinder, single-acting, based on ISO 21287					AEN	AEN
Piston Ø [mm]	16	20	25	32		-...	
Stroke [mm]	1 ... 25					-...	
Type of thread	Male thread					-A	
	Female thread				¹	-I	
Cushioning	Flexible cushioning rings/pads at both ends					-P	-P
Position sensing	Via proximity sensor					-A	-A
O Effective direction of action	Single-acting, pulling					-Z	
Protection against torsion	Square piston rod					-Q	-Q
Male thread extended [mm]	Extended male piston rod thread						
	1 ... 10	1 ... 20				-...K2	
Special piston rod thread Male thread	M8	M10x1.25 M10	M10x1.25 M10	M10		-“...”K5	
Piston rod extended [mm]	Extended piston rod						
	1 ... 25					-...K8	
Temperature resistance	Heat-resistant seals up to max. 120 °C					-S6	
Captive rating plate	Laser etched rating plate					-TL	

¹ I Not with extended male thread K2

M Mandatory data

O Options

Transfer order code

Compact cylinders AEN, to ISO 21287

Ordering data – Modular products, Q – Version with square piston rod, non-rotating

Ordering table								
Size	40	50	63	80	100	Condi- tions	Code	Enter code
M Module No.	536419	536420	536421	536422	536423			
Function	Compact cylinder, single-acting, based on ISO 21287						AEN	AEN
Piston Ø [mm]	40	50	63	80	100		-...	
Stroke [mm]	1 ... 25						-...	
Type of thread	Male thread						-A	
	Female thread					1	-I	
Cushioning	Flexible cushioning rings/pads at both ends						-P	-P
Position sensing	Via proximity sensor						-A	-A
O Effective direction of action	Single-acting, pulling						-Z	
Protection against torsion	Square piston rod						-Q	-Q
Male thread extended [mm]	Extended male piston rod thread 1 ... 20			1 ... 30			...K2	
Special piston rod thread Male thread	M10	M12	M12	M16	M16		-“...”K5	
Piston rod extended [mm]	Extended piston rod 1 ... 25						-...K8	
Temperature resistance	Heat-resistant seals up to max. 120 °C						-S6	
Captive rating plate	Laser etched rating plate						-TL	

1 | Not with extended male thread K2

M Mandatory data

O Options

Transfer order code

- [] - **Q** [] - [] - [] - [] - [] - []

Compact cylinders ADN/AEN, to ISO 21287



Accessories

Foot mounting HNA/HNA-...-R3

Material:

HNA: Galvanised steel

HNA-...-R3: Steel with protective coating

Free of copper and PTFE

RoHS-compliant

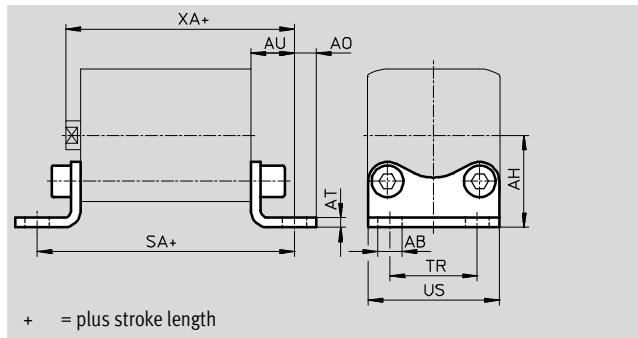

Dimensions and ordering data									
For \varnothing	AB	AH	A0	AT	AU	SA	TR	US	XA
[mm]	\varnothing H14	JS14		± 0.5	± 0.2		± 0.2	-0.5	
12	5.8	21	5	3	13	61	16	26	52.2
16		22	4.75				18	27.5	
20	7	27	6.25	4	16	69	22	34.5	58.7
25		29					26	38.5	
32		33.5					7	32	
40	10	38	9	5	21	87	36	54	69.2
50		45	8				45	64	
63		50	8				50	75	
80	12	63	10.5	6	26	106	63	93	89
100	14.5	74	12.5				27	121	

For \varnothing	Basic version				R3 – High corrosion protection			
	CRC ¹⁾	Weight [g]	Part No.	Type	CRC ¹⁾	Weight [g]	Part No.	Type
[mm]								
12	1	39	537237	HNA-12	3	39	537252	HNA-12-R3
16	1	42	537238	HNA-16	3	42	537253	HNA-16-R3
20	1	84	537239	HNA-20	3	84	537254	HNA-20-R3
25	1	90	537240	HNA-25	3	90	537255	HNA-25-R3
32	1	123	537241	HNA-32	3	123	537256	HNA-32-R3
40	1	157	537242	HNA-40	3	157	537257	HNA-40-R3
50	1	278	537243	HNA-50	3	278	537258	HNA-50-R3
63	1	328	537244	HNA-63	3	328	537259	HNA-63-R3
80	1	634	537249	HNA-80	3	634	537260	HNA-80-R3
100	1	814	537250	HNA-100	3	814	537261	HNA-100-R3

1) Corrosion resistance class CRC 1 to Festo standard FN 940070
 Low corrosion stress. For dry indoor applications or transport and storage protection. Also applies to parts behind covers, in the non-visible interior area, and parts which are covered in the application (e.g. drive trunnions).
 Corrosion resistance class CRC 3 to Festo standard FN 940070
 High corrosion stress. Outdoor exposure under moderate corrosive conditions. External visible parts with primarily functional requirements for the surface and which are in direct contact with a normal industrial environment.

Compact cylinders ADN/AEN, to ISO 21287

Accessories



Flange mounting FNC

Material:
Galvanised steel
Free of copper and PTFE
RoHS-compliant

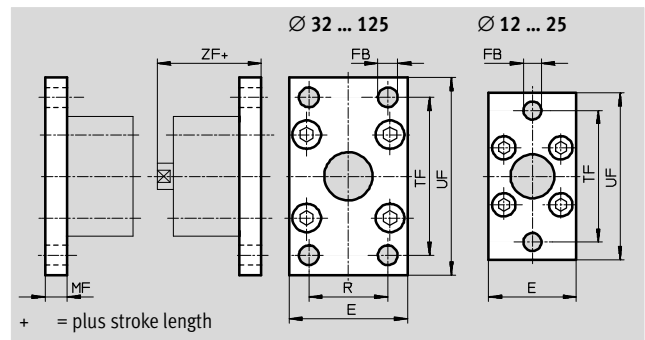

Dimensions and ordering data											
For Ø	E	FB Ø	MF	R	TF	UF	ZF	CRC ¹⁾	Weight	Part No.	Type
[mm]						±1			[g]		
12	28	5.5	8	-	40	50	47.2	1	79	537245	FNC-12
16	29				43	55	47.9	1	88	537246	FNC-16
20	36	6.6			55	70	50.7	1	141	537247	FNC-20
25	40				60	76	52.7	1	165	537248	FNC-25
32	45	7	10	32	64	80	60.2	1	221	★ 174376	FNC-32
40	54	9		36	72	90	61.2	1	291	★ 174377	FNC-40
50	65		12	45	90	110	65.2	1	536	★ 174378	FNC-50
63	75			50	100	120	69.2	1	679	★ 174379	FNC-63
80	93	12	16	63	126	150	79	1	1495	★ 174380	FNC-80
100	110	14		75	150	175	92	1	2041	174381	FNC-100
125	132	16	20	90	180	210	112	1	3775	174382	FNC-125

1) Corrosion resistance class CRC 1 to Festo standard FN 940070
Low corrosion stress. For dry indoor applications or transport and storage protection. Also applies to parts behind covers, in the non-visible interior area, and parts which are covered in the application (e.g. drive trunnions).

Festo core product range

- ★ Generally ready for shipping ex works in 24 hours
- ☆ Generally ready for shipping ex works in 5 days

Compact cylinders ADN/AEN, to ISO 21287

Accessories



Swivel flange SNCL/SNCL-...-R3

Material:

SNCL: 12 ... 25: Wrought aluminium alloy

SNCL: 32 ... 125: Die-cast aluminium alloy
SNCL-...-R3: Wrought aluminium alloy with protective coating

Free of copper and PTFE

RoHS-compliant

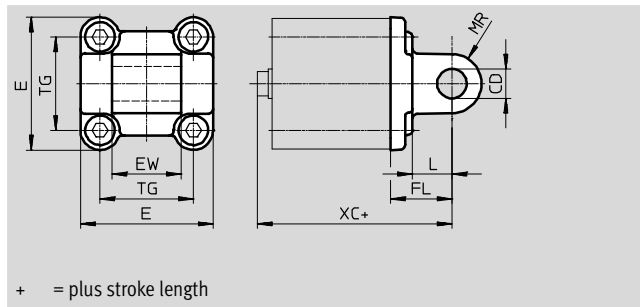

+ = plus stroke length

Dimensions and ordering data								
For \varnothing	CD	E	EW	FL	L	MR	TG	XC
[mm]	\varnothing H9			± 0.2				
12	6	25 _{-0.6}	12 _{h12}	16	10	6	16	55.2
16		27.5 _{-0.6}					18	
20	8	34.5 _{-0.6}	16 _{h12}	20	14	8	22	62.7
25		38.5 _{-0.6}					26	
32	10	45 ^{+0.2/-0.5}	26 _{-0.2/-0.6}	22	13	10	32.5	72.2
40	12	54 _{-0.5}	28 _{-0.2/-0.6}	25	16	12	38	75.2
50		64 _{-0.6}	32 _{-0.2/-0.6}	27			46.5	
63	16	75 _{-0.6}	40 _{-0.2/-0.6}	32	21	16	56.5	89.2
80		93 _{-0.8}	50 _{-0.2/-0.6}	36			72	
100	20	110 _{+0.3/-0.8}	60 _{-0.2/-0.6}	41	27	20	89	117
125	25	131 _{-0.8}	70 _{-0.2/-0.6}	50	30	25	110	142

For \varnothing	Basic version				R3 – High corrosion protection			
	CRC ¹⁾	Weight [g]	Part No.	Type	CRC ¹⁾	Weight [g]	Part No.	Type
[mm]								
12	2	20	537790	SNCL-12	3	20	537794	SNCL-12-R3
16	2	21	537791	SNCL-16	3	21	537795	SNCL-16-R3
20	2	38	537792	SNCL-20	3	38	537796	SNCL-20-R3
25	2	41	537793	SNCL-25	3	41	537797	SNCL-25-R3
32	1	71	★ 174404	SNCL-32	–	–	–	–
40	1	95	★ 174405	SNCL-40	–	–	–	–
50	1	158	★ 174406	SNCL-50	–	–	–	–
63	1	225	★ 174407	SNCL-63	–	–	–	–
80	1	436	★ 174408	SNCL-80	–	–	–	–
100	1	606	174409	SNCL-100	–	–	–	–
125	1	1135	174410	SNCL-125	–	–	–	–

1) Corrosion resistance class CRC 1 to Festo standard FN 940070

Low corrosion stress. For dry indoor applications or transport and storage protection. Also applies to parts behind covers, in the non-visible interior area, and parts which are covered in the application (e.g. drive trunnions).

Corrosion resistance class CRC 2 to Festo standard FN 940070

Moderate corrosion stress. Indoor applications in which condensation may occur. External visible parts with primarily decorative requirements for the surface and which are in direct contact with the ambient atmosphere typical for industrial applications.

Corrosion resistance class CRC 3 to Festo standard FN 940070

High corrosion stress. Outdoor exposure under moderate corrosive conditions. External visible parts with primarily functional requirements for the surface and which are in direct contact with a normal industrial environment.

Festo core product range

- ★ Generally ready for shipping ex works in 24 hours
- ☆ Generally ready for shipping ex works in 5 days

Compact cylinders ADN/AEN, to ISO 21287

Accessories

Swivel flange

SNCS/CRSNCS/SNCS-...-R3

Material:

SNCS 32 ... 50: Die-cast aluminium

SNCS 63 ... 125:

Wrought aluminium alloy

CRSNCS 32 ... 80:

High-alloy stainless steel

SNCS-...-R3: 100 ... 125: Wrought aluminium alloy with protective coating

RoHS-compliant

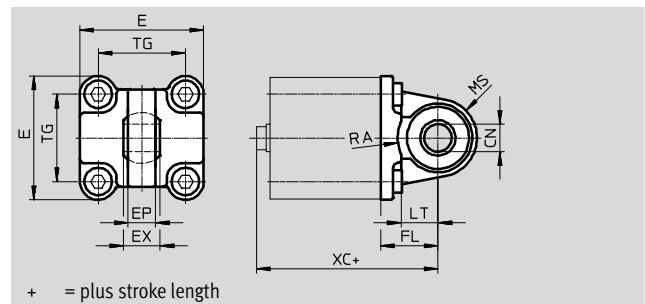
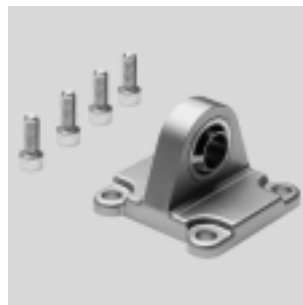

Dimensions and ordering data							
For \varnothing [mm]	CN \varnothing		E		EP ± 0.2	EX	FL ± 0.2
	ADN-...	ADN-...-R3	ADN-...	ADN-...-R3			
32	10 ^{+0.013}	10 ^{+0.015/-0.04}	45 ^{+0.2/-0.5}	45 _{-0.5}	10.5	14	22
40	12 ^{+0.015}	12 ^{+0.018/-0.04}	54 _{-0.5}	54 _{-0.5}	12	16	25
50	16 ^{+0.015}	16 ^{+0.018/-0.04}	64 _{-0.6}	64 _{-0.6}	15	21	27
63	16 ^{+0.015}	16 ^{+0.018/-0.04}	74,5 ± 0.5	75 _{-0.6}	15	21	32
80	20 ^{+0.018}	20 ^{+0.021/-0.04}	92,2 ± 0.8	93 _{-0.8}	18	25	36
100	20 ^{+0.018}	20 ^{+0.021/-0.04}	109 ^{+1/-0.7}	109 ^{+1/-0.7}	18	25	41
125	30 ^{+0.018}	30 ^{+0.021/-0.04}	132 ^{+1/-0.7}	132 ^{+1/-0.7}	25	37	50

For \varnothing [mm]	LT	MS		RA		TG	XC
		ADN-...	ADN-...-R3	ADN-... +1	ADN-...-R3 +1		
32	13	15 ^{+0.5}	15 ^{+0.5}	14.5	14.5	32.5	72.2
40	16	17 ^{+0.5}	17 ^{+0.5}	17.5	17.5	38	75.2
50	16	20 ^{+0.5}	20 ^{+0.5}	18.5	19	46.5	80.2
63	21	23 _{-0.5}	22 ^{+0.5}	23	23	56.5	89.2
80	22	28 _{-0.5}	27 ^{+0.5}	25	25	72	99
100	27	30 ± 0.5	30 ± 0.5	95	100	89	117
125	30	39 ± 0.5	39 ± 0.5	100	100	110	142

For \varnothing [mm]	Basic version				High corrosion protection			
	CRC ¹⁾	Weight [g]	Part No.	Type	CRC ¹⁾	Weight [g]	Part No.	Type
32	1	86	★ 174397	SNCS-32	4	161	2895920	CRSNCS-32
40	1	122	★ 174398	SNCS-40	4	239	2895921	CRSNCS-40
50	1	216	★ 174399	SNCS-50	4	403	2895922	CRSNCS-50
63	2	281	★ 174400	SNCS-63	4	576	2895923	CRSNCS-63
80	2	557	★ 174401	SNCS-80	4	1173	2895924	CRSNCS-80
100	2	683	174402	SNCS-100	3	684	2895925	SNCS-100-R3
125	2	1369	174403	SNCS-125	3	1369	2895926	SNCS-125-R3

1) Corrosion resistance class CRC 1 to Festo standard FN 940070

Low corrosion stress. For dry indoor applications or transport and storage protection. Also applies to parts behind covers, in the non-visible interior area, and parts which are covered in the application (e.g. drive trunnions).

Corrosion resistance class CRC 2 to Festo standard FN 940070

Moderate corrosion stress. Indoor applications in which condensation may occur. External visible parts with primarily decorative requirements for the surface and which are in direct contact with the ambient atmosphere typical for industrial applications.

Corrosion resistance class CRC 3 to Festo standard FN 940070

High corrosion stress. Outdoor exposure under moderate corrosive conditions. External visible parts with primarily functional requirements for the surface and which are in direct contact with a normal industrial environment.

Corrosion resistance class CRC 4 to Festo standard FN 940070

Particularly high corrosion stress. Outdoor exposure under extreme corrosive conditions. Parts exposed to aggressive media, for instance in the chemical or food industries. These applications may need to be supported by special tests (→ also FN 940082) using appropriate media.

Festo core product range

★ Generally ready for shipping ex works in 24 hours

☆ Generally ready for shipping ex works in 5 days

Compact cylinders ADN/AEN, to ISO 21287

Accessories

Clevis foot LBG/LBG-R3

The clevis foot is secured against rotation with a dowel pin.

Material:

LBG 32 ... 63: Special steel casting

LBG 80 ... 125: Nodular graphite cast iron

LBG-...-R3: High-alloy stainless steel

Free of copper and PTFE

RoHS-compliant

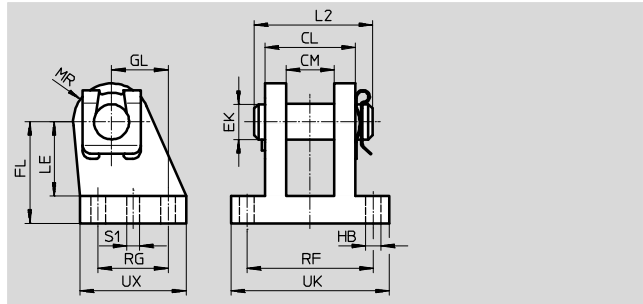

Dimensions and ordering data														
For \varnothing	CL	CM	EK	FL	GL	HB	L2	LE	MR	RF	RG	S1	UK	UX
[mm]	± 0.2		\varnothing			\varnothing						\varnothing		
32	28	14.1	10	32	16	6.8	35	24	12	42	20	4.8	56	36
40	30	16.1	12	36	20	6.8	39	26	14	44	26	5.8	58	41.5
50	40	21.1	16	45	25	9.2	50	33	15	56	31	5.8	70	47
63	40	21.1	16	50	25	9	50	38	17	56	31	7.8	70	49
80	50	25.1	20	63	30	11	60	49	18	70	36	7.8	89	55
100	50	25.1	20	71	41	11	60	56	22	70	46	9.8	89	65
125	80	37.2	30	90	60	14	89	70	26	106	70	11.8	128	96

For \varnothing	Basic version				R3 – High corrosion protection			
	CRC ¹⁾	Weight [g]	Part No.	Type	CRC ¹⁾	Weight [g]	Part No.	Type
[mm]								
32	2	220	31761	LBG-32	3	220	2078790	LBG-32-R3
40	2	300	31762	LBG-40	3	300	2078792	LBG-40-R3
50	2	540	31763	LBG-50	3	540	2078794	LBG-50-R3
63	2	580	31764	LBG-63	3	580	2078795	LBG-63-R3
80	2	1050	31765	LBG-80	3	1050	2078797	LBG-80-R3
100	2	1375	31766	LBG-100	3	1375	2078799	LBG-100-R3
125	2	4140	31767	LBG-125	3	4140	2078837	LBG-125-R3

1) Corrosion resistance class CRC 2 to Festo standard FN 940070
 Moderate corrosion stress. Indoor applications in which condensation may occur. External visible parts with primarily decorative requirements for the surface and which are in direct contact with the ambient atmosphere typical for industrial applications.
 Corrosion resistance class CRC 3 to Festo standard FN 940070
 High corrosion stress. Outdoor exposure under moderate corrosive conditions. External visible parts with primarily functional requirements for the surface and which are in direct contact with a normal industrial environment.

Compact cylinders ADN/AEN, to ISO 21287

Accessories



Multi-position kit DPNA

Material:

Flange: Wrought aluminium alloy

Screws: Galvanised steel

Free of copper and PTFE

RoHS-compliant

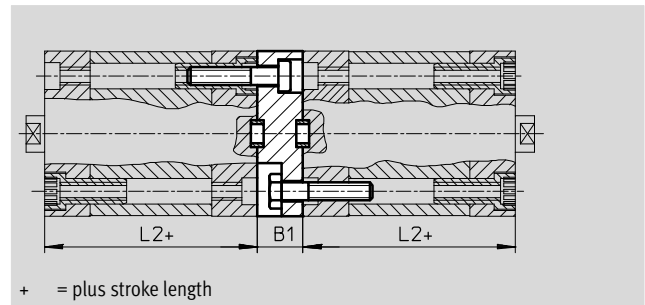

Dimensions and ordering data							
For Ø [mm]	L2	B1	Max. overall stroke length [mm]	CRC ¹⁾	Weight [g]	Part No.	Type
12	35	13	600	2	28	537263	DPNA-12
16					33	537264	DPNA-16
20					50	537265	DPNA-20
25					60	537266	DPNA-25
32	44	15	800		99	537267	DPNA-32
40	45				129	537268	DPNA-40
50					196	537269	DPNA-50
63	49				249	537270	DPNA-63
80	54	17	1000		474	537271	DPNA-80
100	67	19.5			712	537272	DPNA-100

Note

The maximum overall stroke length may not be exceeded when combining cylinders and multi-position kits.

1) Corrosion resistance class CRC 2 to Festo standard FN 940070

Moderate corrosion stress. Indoor applications in which condensation may occur. External visible parts with primarily decorative requirements for the surface and which are in direct contact with the ambient atmosphere typical for industrial applications.

Compact cylinders ADN/AEN, to ISO 21287

FESTO

Accessories

Clevis foot LBN

Material:
Galvanised steel
Free of copper and PTFE
RoHS-compliant

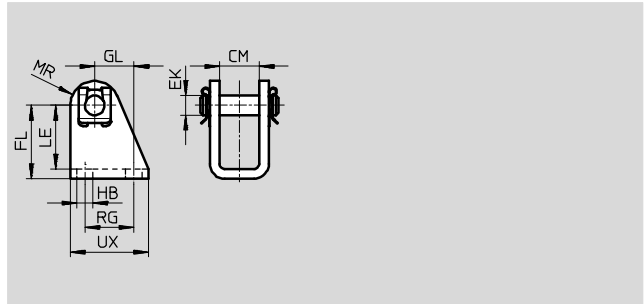

Dimensions and ordering data													
For \varnothing	CM	EK \varnothing	FL	GL	HB \varnothing	LE	MR	RG	UX	CRC ¹⁾	Weight [g]	Part No.	Type
[mm]													
12/16	12.1	6	27 +0.3/-0.2	13	5.5	24	7	15	25	1	40	★ 6058	LBN-12/16
20/25	16.1	8	30 +0.4/-0.2	16	6.6	26	10	20	32	1	84	★ 6059	LBN-20/25

1) Corrosion resistance class CRC 1 to Festo standard FN 940070
Low corrosion stress. For dry indoor applications or transport and storage protection. Also applies to parts behind covers, in the non-visible interior area, and parts which are covered in the application (e.g. drive trunnions).

Clevis foot CRLBN, stainless steel

Material:
High-alloy steel
Free of copper and PTFE
RoHS-compliant

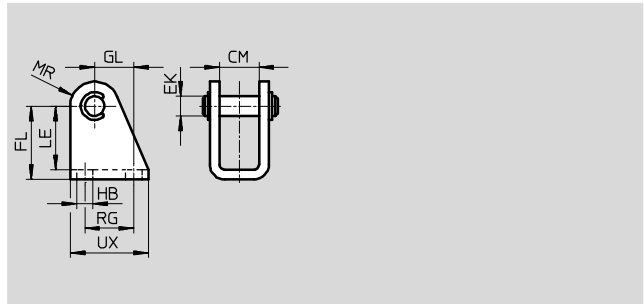

Dimensions and ordering data													
For \varnothing	CM	EK \varnothing	FL	GL	HB	LE	MR	RG	UX	CRC ¹⁾	Weight [g]	Part No.	Type
[mm]													
12/16	12.1	6	27 +0.3/-0.2	13	5.5	24	7	15	25	4	39	161862	CRLBN-12/16
20/25	16.1	8	30 +0.4/-0.2	16	6.6	26	10	20	32	4	82	161863	CRLBN-20/25

1) Corrosion resistance class CRC 4 to Festo standard FN 940070
Particularly high corrosion stress. Outdoor exposure under extreme corrosive conditions. Parts exposed to aggressive media, for instance in the chemical or food industries. These applications may need to be supported by special tests (→ also FN 940082) using appropriate media.

Festo core product range

- ★ Generally ready for shipping ex works in 24 hours
- ☆ Generally ready for shipping ex works in 5 days

Compact cylinders ADN/AEN, to ISO 21287

Accessories

Swivel flange SNCB/SNCB-...-R3

Material:
SNCB: Die-cast aluminium
SNCB-...-R3: Die-cast aluminium with protective coating
Free of copper and PTFE
RoHS-compliant

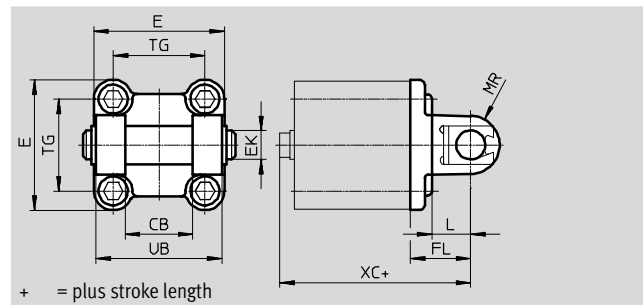

Dimensions and ordering data									
For Ø	CB	E	EK Ø	FL	L	MR	TG	UB	XC
[mm]	H14		H9/e8	±0.2		-0.5		h14	
32	26	45 ^{+0.2/-0.5}	10	22	13	8.5	32.5	45	72
40	28	54 ^{-0.5}	12	25	16	12	38	52	76
50	32	64 ^{-0.6}	12	27	16	12	46.5	60	80
63	40	75 ^{-0.6}	16	32	21	16	56.5	70	89
80	50	93 ^{-0.8}	16	36	22	16	72	90	99
100	60	110 ^{+0.3/-0.8}	20	41	27	20	89	110	117
125	70	131 ^{-0.8}	25	50	30	25	110	130	142

For Ø [mm]	Basic version				R3 – High corrosion protection			
	CRC ¹⁾	Weight [g]	Part No.	Type	CRC ¹⁾	Weight [g]	Part No.	Type
32	1	103	★ 174390	SNCB-32	3	100	176944	SNCB-32-R3
40	1	155	★ 174391	SNCB-40	3	151	176945	SNCB-40-R3
50	1	232	★ 174392	SNCB-50	3	228	176946	SNCB-50-R3
63	1	375	★ 174393	SNCB-63	3	371	176947	SNCB-63-R3
80	1	636	★ 174394	SNCB-80	3	632	176948	SNCB-80-R3
100	1	1035	174395	SNCB-100	3	986	176949	SNCB-100-R3
125	1	1860	174396	SNCB-125	3	1776	176950	SNCB-125-R3

1) Corrosion resistance class CRC 1 to Festo standard FN 940070
Low corrosion stress. For dry indoor applications or transport and storage protection. Also applies to parts behind covers, in the non-visible interior area, and parts which are covered in the application (e.g. drive trunnions).
Corrosion resistance class CRC 3 to Festo standard FN 940070
High corrosion stress. Outdoor exposure under moderate corrosive conditions. External visible parts with primarily functional requirements for the surface and which are in direct contact with a normal industrial environment.

Festo core product range

- ★ Generally ready for shipping ex works in 24 hours
- ☆ Generally ready for shipping ex works in 5 days

Compact cylinders ADN/AEN, to ISO 21287

Accessories

FESTO

Trunnion flange ZNCF/CRZNG

Material:

ZNCF: Special steel casting
 CRZNG: Electrolytically polished special steel casting
 Free of copper and PTFE
 RoHS-compliant

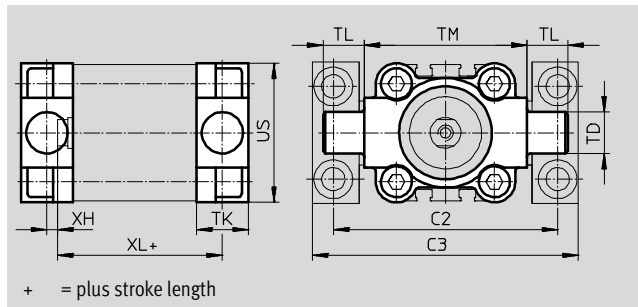

Dimensions and ordering data									
For \varnothing	C2	C3	TD	TK	TL	TM	US	XH	XL
[mm]			\varnothing e9						
32	71	86	12	16	12	50	45	2	58
40	87	105	16	20	16	63	54	4	61.1
50	99	117	16	24	16	75	64	4	64.7
63	116	136	20	24	20	90	75	4	68.5
80	136	156	20	28	20	110	93	5	76.9
100	164	189	25	38	25	132	110	10	95
125	192	217	25	50	25	160	131	14	117

For \varnothing	Basic version				R3 – High corrosion protection			
	CRC ¹⁾	Weight [g]	Part No.	Type	CRC ¹⁾	Weight [g]	Part No.	Type
[mm]								
32	2	150	174411	ZNCF-32	4	150	161852	CRZNG-32
40	2	285	174412	ZNCF-40	4	285	161853	CRZNG-40
50	2	473	174413	ZNCF-50	4	473	161854	CRZNG-50
63	2	687	174414	ZNCF-63	4	687	161855	CRZNG-63
80	2	1296	174415	ZNCF-80	4	1296	161856	CRZNG-80
100	2	2254	174416	ZNCF-100	4	2254	161857	CRZNG-100
125	2	3484	174417	ZNCF-125	4	3484	185362	CRZNG-125

1) Corrosion resistance class CRC 2 to Festo standard FN 940070
 Moderate corrosion stress. Indoor applications in which condensation may occur. External visible parts with primarily decorative requirements for the surface and which are in direct contact with the ambient atmosphere typical for industrial applications.
 Corrosion resistance class CRC 4 to Festo standard FN 940070
 Particularly high corrosion stress. Outdoor exposure under extreme corrosive conditions. Parts exposed to aggressive media, for instance in the chemical or food industries. These applications may need to be supported by special tests (→ also FN 940082) using appropriate media.

Compact cylinders ADN/AEN, to ISO 21287

Accessories

Trunnion support LNZG

Material:
 Trunnion support: Anodised aluminium
 Plain bearing: Plastic
 Free of copper and PTFE
 RoHS-compliant

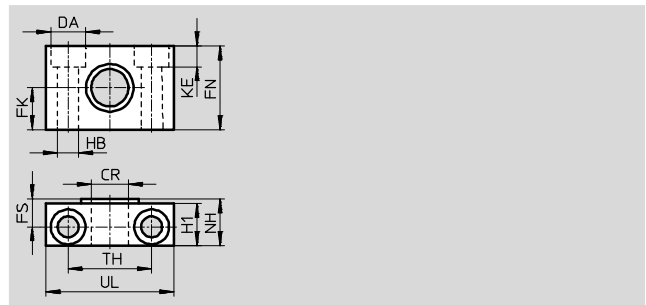
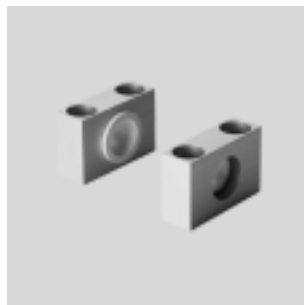







Dimensions and ordering data														Weight	Part No.	Type
For \varnothing	CR	DA	FK	FN	FS	H1	HB	KE	NH	TH	UL	CRC ¹⁾				
[mm]	\varnothing D11	\varnothing H13	\varnothing ± 0.1				\varnothing H13			± 0.2				[g]		
32	12	11	15	30	10.5	15	6.6	6.8	18	32	46	2		83	32959	LNZG-32
40, 50	16	15	18	36	12	18	9	9	21	36	55	2		129	32960	LNZG-40/50
63, 80	20	18	20	40	13	20	11	11	23	42	65	2		178	32961	LNZG-63/80
100, 125	25	20	25	50	16	24.5	14	13	28.5	50	75	2		306	32962	LNZG-100/125

1) Corrosion resistance class CRC 2 to Festo standard FN 940070
 Moderate corrosion stress. Indoor applications in which condensation may occur. External visible parts with primarily decorative requirements for the surface and which are in direct contact with the ambient atmosphere typical for industrial applications.

Compact cylinders ADN/AEN, to ISO 21287

Accessories

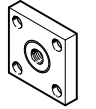
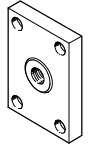
FESTO

Ordering data – Piston rod attachments				Technical data → Internet: piston-rod attachment			
Designation	For Ø	Part No.	Type	Designation	For Ø	Part No.	Type
Rod eye SGS				Rod clevis SGA used in combination with rod eye SGS			
	12	–			12, 16, 20, 25	–	
	16	★ 9254	SGS-M6		32, 40	32954	SGA-M10x1,25
	20, 25	★ 9255	SGS-M8		50, 63	10767	SGA-M12x1,25
	32, 40	★ 9261	SGS-M10x1,25		80, 100	10768	SGA-M16x1,25
	50, 63	★ 9262	SGS-M12x1,25		125	10769	SGA-M20x1,25
	80, 100	★ 9263	SGS-M16x1,5				
	125	★ 9264	SGS-M20x1,5				
Rod clevis SG				Self-aligning rod coupler FK			
	12	–			12	30984	FK-M5
	16	★ 3110	SG-M6		16	★ 2061	FK-M6
	20, 25	★ 3111	SG-M8		20, 25	★ 2062	FK-M8
	32, 40	★ 6144	SG-M10x1,25		32, 40	★ 6140	FK-M10x1,25
	50, 63	★ 6145	SG-M12x1,25		50, 63	★ 6141	FK-M12x1,25
	80, 100	★ 6146	SG-M16x1,5		80, 100	★ 6142	FK-M16x1,5
125	★ 6147	SG-M20x1,5	125		★ 6143	FK-M20x1,5	
Coupling piece KSG					Coupling piece KSZ		
	12, 16, 20, 25	–			12	–	
	32, 40	32963	KSG-M10x1,25		16	36123	KSZ-M6
	50, 63	32964	KSG-M12x1,25		20, 25	36124	KSZ-M8
	80, 100	32965	KSG-M16x1,5		32, 40	36125	KSZ-M10x1,25
	125	32966	KSG-M20x1,5		50, 63	36126	KSZ-M12x1,25
					80, 100	36127	KSZ-M16x1,5
			125		36128	KSZ-M20x1,5	
Adapter AD							
	12	–					
	16	157328	AD-M6-M5				
		157329	AD-M6-1/8				
		157330	AD-M6-1/4				
	20	157331	AD-M8-1/8				
	25	157332	AD-M8-1/4				
	32	157333	AD-M10x1,25-1/8				
	40	157334	AD-M10x1,25-1/4				
	50	160256	AD-M12x1,25-1/4				
	63	160257	AD-M12x1,25-3/8				



Festo core product range

- ★ Generally ready for shipping ex works in 24 hours
- ☆ Generally ready for shipping ex works in 5 days

Compact cylinders ADN/AEN, to ISO 21287

Accessories

FESTO

Ordering data – Corrosion and acid resistant piston rod attachments				Technical data → Internet: crsg			
Designation	For Ø	Part No.	Type	Designation	For Ø	Part No.	Type
Rod eye CRSGS				Rod clevis CRSG			
	12	–			12	–	
	16	195580	CRSGS-M6		16, 20	13567	CRSG-M6
	20, 25	195581	CRSGS-M8		20, 25	13568	CRSG-M8
	32, 40	195582	CRSGS-M10x1,25		32, 40	13569	CRSG-M10x1,25
	50, 63	195583	CRSGS-M12x1,25		50, 63	13570	CRSG-M12x1,25
	80, 100	195584	CRSGS-M16x1,5		80, 100	13571	CRSG-M16x1,5
	125	195585	CRSGS-M20x1,5		125	13572	CRSG-M20x1,5
Self-aligning rod coupler CRFK							
	32, 40	2305778	CRFK-M10x1,25				
	50, 63	2305779	CRFK-M12x1,25				
	80, 100	2490673	CRFK-M16x1,5				
	125	2545677	CRFK-M20x1,5				

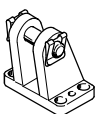
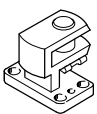
Ordering data – Mounting attachments				Technical data → Internet: clevis foot			
Designation	For Ø	Part No.	Type	Designation	For Ø	Part No.	Type
Clevis foot LBG for rod eye SGS				Right-angle clevis foot LQG for rod eye SGS			
	32, 40	31761	LBG-32		32, 40	31768	LQG-32
	50, 63	31762	LBG-40		50, 63	31769	LQG-40
	80, 100	31763	LBG-50		80, 100	31770	LQG-50
		31764	LBG-63			31771	LQG-63
	125	31765	LBG-80		125	31772	LQG-80
		31766	LBG-100			31773	LQG-100

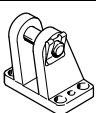
Ordering data – Mounting attachments, R3 – High corrosion protection				Technical data → Internet: lagerbock				
Designation	For Ø	Part No.	Type	Designation	For Ø	Part No.	Type	
Clevis foot LBG-R3 for rod eye CRSGS								
	32, 40					2078790	LBG-32-R3	
	50, 63					2078792	LBG-40-R3	
	80, 100						2078794	LBG-50-R3
							2078795	LBG-63-R3
	125						2078797	LBG-80-R3
						2078799	LBG-100-R3	

Ordering data – One-way flow control valves				Technical data → Internet: grla					
Designation	Connection		Material	Part No.	Type				
	For Ø	For tubing O.D.							
For exhaust air									
	12, 16, 20, 25	3	Metal design	★	193137	GRLA-M5-QS-3-D			
		4					★	193138	GRLA-M5-QS-4-D
		6					★	193139	GRLA-M5-QS-6-D
	32, 40, 50, 63, 80, 100	3					★	193142	GRLA-1/8-QS-3-D
		4					★	193143	GRLA-1/8-QS-4-D
		6					★	193144	GRLA-1/8-QS-6-D
		8					★	193145	GRLA-1/8-QS-8-D
		125					6	★	193146
	8						★	193147	GRLA-1/4-QS-8-D
	10						★	193148	GRLA-1/4-QS-10-D

Festo core product range

- ★ Generally ready for shipping ex works in 24 hours
- ☆ Generally ready for shipping ex works in 5 days

Compact cylinders ADN/AEN, to ISO 21287

Accessories

FESTO

Ordering data – One-way flow control valves				Technical data → Internet: grlz	
Connection	Material		Part No.	Type	
	For Ø	For tubing O.D.			
For supply air					
	12, 16, 20, 25	3	Metal design	★ 193153	GRLZ-M5-QS-3-D
		4		★ 193154	GRLZ-M5-QS-4-D
		6		★ 193155	GRLZ-M5-QS-6-D
	32, 40, 50, 63, 80, 100	3		★ 193156	GRLZ-1/8-QS-3-D
		4		★ 193157	GRLZ-1/8-QS-4-D
		6		★ 193158	GRLZ-1/8-QS-6-D
		8		★ 193159	GRLZ-1/8-QS-8-D
	125	–		151195	GRLZ-1/4-B

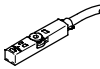
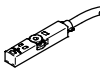
Ordering data – Proximity sensors for T-slot, magneto-resistive					Technical data → Internet: smt	
Type of mounting	Switch output	Electrical connection	Cable length [m]	Part No.	Type	
N/O contact						
	Insertable in the slot from above, flush with cylinder profile, short design	PNP	Cable, 3-wire	2.5	★ 574335	SMT-8M-A-PS-24V-E-2,5-OE
			Plug M8x1, 3-pin	0.3	★ 574334	SMT-8M-A-PS-24V-E-0,3-M8D
			Plug M12x1, 3-pin	0.3	★ 574337	SMT-8M-A-PS-24V-E-0,3-M12
		NPN	Cable, 3-wire	2.5	★ 574338	SMT-8M-A-NS-24V-E-2,5-OE
			Plug M8x1, 3-pin	0.3	★ 574339	SMT-8M-A-NS-24V-E-0,3-M8D
N/C contact						
	Insertable in the slot from above, flush with cylinder profile, short design	PNP	Cable, 3-wire	7.5	★ 574340	SMT-8M-A-PO-24V-E-7,5-OE

Festo core product range



★ Generally ready for shipping ex works in 24 hours



☆ Generally ready for shipping ex works in 5 days

Compact cylinders ADN/AEN, to ISO 21287

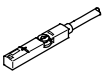
Accessories

FESTO

Ordering data – Proximity sensors for T-slot, magnetic reed						Technical data → Internet: sme
	Type of mounting	Switch output	Electrical connection	Cable length [m]	Part No.	Type
N/O contact						
	Insertable in the slot from above, flush with cylinder profile	Contacting	Cable, 3-wire	2.5	★ 543862	SME-8M-DS-24V-K-2,5-OE
				5.0	★ 543863	SME-8M-DS-24V-K-5,0-OE
			Plug M8x1, 3-pin	2.5	★ 543872	SME-8M-ZS-24V-K-2,5-OE
				0.3	★ 543861	SME-8M-DS-24V-K-0,3-M8D
	Insertable in the slot lengthwise, flush with the cylinder profile	Contacting	Cable, 3-wire	2.5	150855	SME-8-K-LED-24
			Plug M8x1, 3-pin	0.3	150857	SME-8-S-LED-24
N/C contact						
	Insertable in the slot lengthwise, flush with the cylinder profile	Contacting	Cable, 3-wire	7.5	160251	SME-8-O-K-LED-24

Ordering data – Connecting cables					Technical data → Internet: nebu
	Electrical connection, left	Electrical connection, right	Cable length [m]	Part No.	Type
	Straight socket, M8x1, 3-pin	Cable, open end, 3-wire	2.5	★ 541333	NEBU-M8G3-K-2.5-LE3
			5	★ 541334	NEBU-M8G3-K-5-LE3
	Straight socket, M12x1, 5-pin	Cable, open end, 3-wire	2.5	★ 541363	NEBU-M12G5-K-2.5-LE3
			5	★ 541364	NEBU-M12G5-K-5-LE3
	Angled socket, M8x1, 3-pin	Cable, open end, 3-wire	2.5	★ 541338	NEBU-M8W3-K-2.5-LE3
			5	★ 541341	NEBU-M8W3-K-5-LE3
	Angled socket, M12x1, 5-pin	Cable, open end, 3-wire	2.5	541367	NEBU-M12W5-K-2.5-LE3
			5	541370	NEBU-M12W5-K-5-LE3

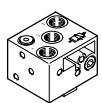
Ordering data – Rectangular proximity sensors, pneumatic			Technical data → Internet: smpo
	Pneumatic connection	Part No.	Type
3/2-way valve, normally closed			
	Female thread M5	178563	SMPO-8E

Ordering data – Mounting kits for proximity sensors SMPO-8E			Technical data → Internet: smb
	Assembly	Part No.	Type
	Clamped in T-slot	178230	SMB-8E

Ordering data – Slot cover for T-slot				
	Assembly	Length	Part No.	Type
	Insertable from above	2x 0.5 m	151680	ABP-5-S

Festo core product range

- ★ Generally ready for shipping ex works in 24 hours
- ☆ Generally ready for shipping ex works in 5 days