

2.4

Pilot Actuated Valves

Selected valves can be used for technical vacuum too.



Selected models are available for low temperature application.
Temperature-range: - 50° C to + 50° C.
For detailed information refer to chapter 2.11.

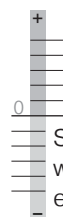

Selected models can be equipped with FKM seals for high temperature environment up to 120 °C.



316 Selected models are available in stainless steel.
For detailed information refer to chapter 2.12.

Selected models are available for explosion hazardous environment. They are ATEX-Ex certified.
For detailed information refer to chapter 2.14.

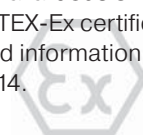

P 310 302/P 310 502

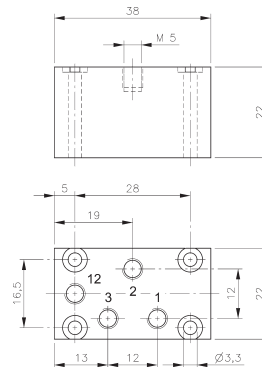
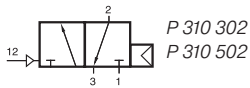

P 310 302

Pneumatically actuated 3/2-way spool valve with air spring return.

If pressure is attached to port 1 the function is normally closed.

If pressure is applied to port 3 the function is normally open.

Do not attach pressure at port 2.

Operating pressure and actuating pressure should be at the same level.

Exhaust can be throttled.

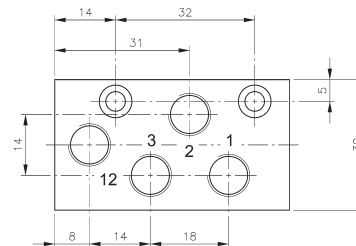
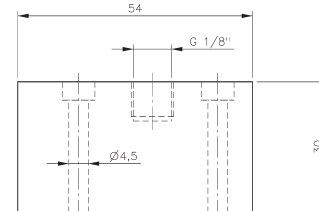

P 310 502

Type	Port size	Air flow	Operating press.	Actuating press.	Weight
P 310 302	M5	180 l/min	2 - 10 bar	the same	0,05 kg
P 310 502	G 1/8"	650 l/min	2 - 10 bar	the same	0,13 kg

P 310 501/P 310 701/P 310 801 P 311 501/P 311 701/P 311 801

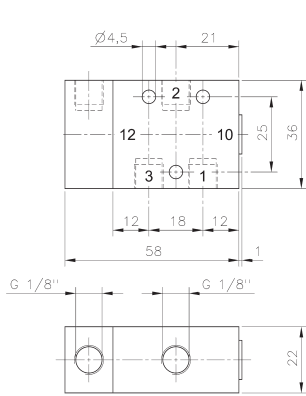

P 310 501/P 311 501

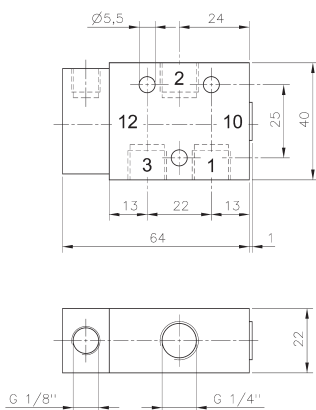

P 310 701/P 311 701

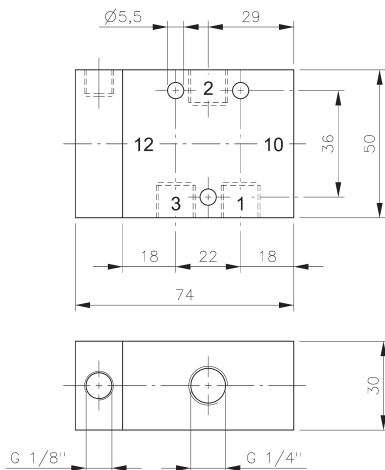

P 310 801/P 311 801

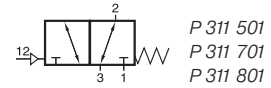
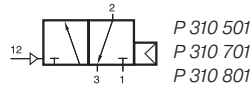

Pneumatically actuated 3/2-way spool valve.

Type P 310 ___ with air-spring-return.
Operating pressure and actuating pressure should be at the same level.

Type P 311 ___ with mechanical spring return.

If pressure is attached to port 1 the function is normally closed.

If pressure is applied to port 3 the function is normally open.

Pressure can only be attached to port 2 if valve has a mechanical spring (type P 311 ___).

Exhaust can be throttled.

Type	Port size	Air flow	Operating press.	Actuating press.	Weight	
P 310 501	G 1/8"	650 l/min	2 - 10 bar	the same	0,13 kg	Ex
P 310 701	G 1/4"	1250 l/min	2 - 10 bar	the same	0,14 kg	Ex 316
P 310 801	G 1/4"	1450 l/min	1,5 - 10 bar	the same	0,29 kg	Ex
P 311 501	G 1/8"	650 l/min	1 - 10 bar	3 - 10 bar	0,13 kg	Ex
P 311 701	G 1/4"	1250 l/min	1 - 10 bar	3 - 10 bar	0,14 kg	Ex 316
P 311 801	G 1/4"	1450 l/min	1 - 10 bar	3 - 10 bar	0,29 kg	Ex

P 310 101/P 310 121/P 310 181 P 311 101/P 311 121/P 311 181

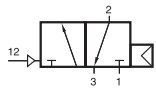

P 310 101
P 310 121
P 310 181
P 310 121 NPT

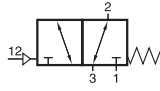

P 311 101
P 311 121
P 311 181
P 311 121 NPT

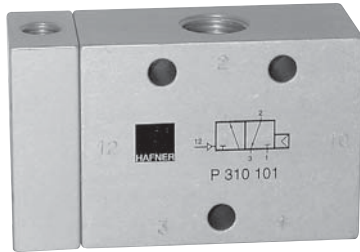

Pneumatically actuated 3/2-way spool valve.

Type P 310 ___ with air-spring-return.
Operating pressure and actuating pressure should be at the same level.

Type P 311 ___ with mechanical spring return.

If pressure is attached to port 1 the function is normally closed.
If pressure is applied to port 3 the function is normally open.
Pressure can only be attached to port 2 if valve has a mechanical spring (type P 311___).

Exhaust can be throttled.

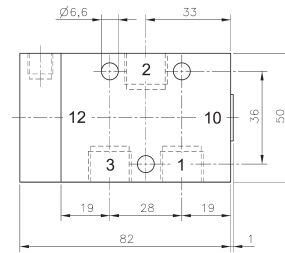

P 310 101/P 311 101

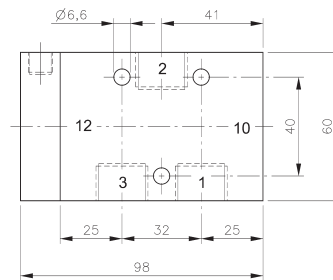

P 310 121/P 311 121
P 310 121 NPT/P 311 121 NPT

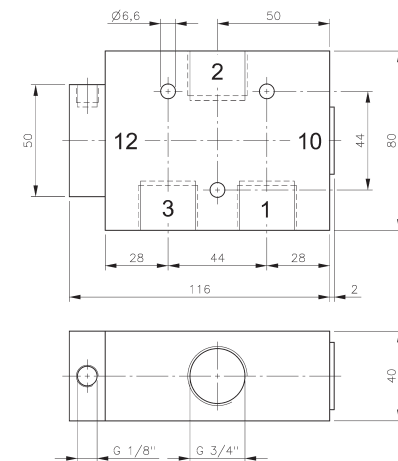

P 310 181/P 311 181

Type	Port size	Air flow	Operating press.	Actuating press.	Weight	
P 310 101	G 3/8"	2250 l/min	1 - 10 bar	the same	0,32 kg	Ex
P 310 121	G 1/2"	3000 l/min	1 - 10 bar	the same	0,45 kg	Ex 316
P 310 181	G 3/4"	6000 l/min	1 - 10 bar	the same	0,85 kg	
P 311 101	G 3/8"	2250 l/min	1 - 10 bar	3 - 10 bar	0,32 kg	
P 311 121	G 1/2"	3000 l/min	1 - 10 bar	3 - 10 bar	0,45 kg	316
P 311 181	G 3/4"	6000 l/min	1 - 10 bar	3 - 10 bar	0,85 kg	
P 310 121 NPT	1/2" NPT	3000 l/min	1 - 10 bar	the same	0,45 kg	Ex 316
P 311 121 NPT	1/2" NPT	3000 l/min	1 - 10 bar	3 - 10 bar	0,45 kg	316

P 310 701 G/P 311 701 G P 310 121 G/P 311 121 G

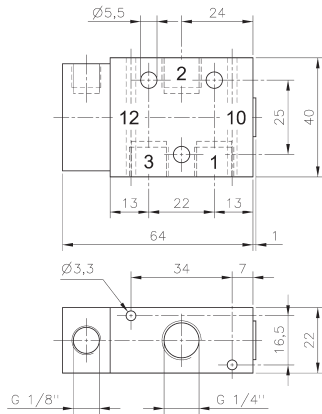
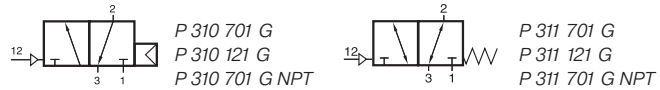

**P 310 701 G/P 311 701 G
P 310 701 G NPT/ P 311 701 G NPT**

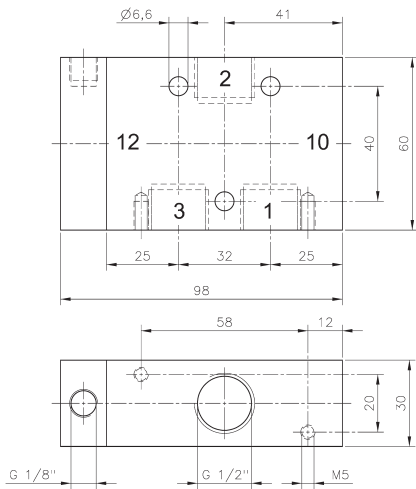

P 310 121 G/P 311 121 G

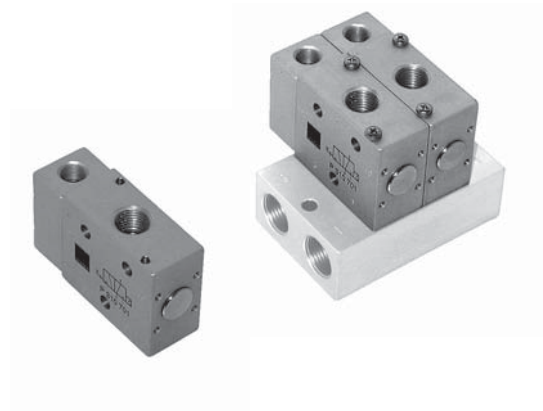

Pneumatically actuated 3/2-way spool valve.

Type P 310 ___ with air-spring-return.
Operating pressure and actuating pressure should be at the same level.

Type P 311 ___ with mechanical spring return.

If pressure is attached to port 1 the function is normally closed.
If pressure is applied to port 3 the function is normally open.
Pressure can only be attached to port 2 if valve has a mechanical spring (type P 311___).

Valves can either be used in-line or on a manifold plate. Plates are displayed on page 2.7.1.4 and 2.7.1.5.

Take into consideration that G 1/2" valves have to be assembled onto the plate by fixing screws from the bottom through the plate into the valve.

Exhaust can be throttled.

Type	Port size	Air flow	Operating press.	Actuating press.	Weight
P 310 701 G	G 1/4"	1250 l/min	2 - 10 bar	the same	0,14 kg ❄️
P 310 121 G	G 1/2"	3000 l/min	1 - 10 bar	the same	0,45 kg
P 311 701 G	G 1/4"	1250 l/min	1 - 10 bar	3 - 10 bar	0,14 kg ❄️
P 311 121 G	G 1/2"	3000 l/min	1 - 10 bar	3 - 10 bar	0,45 kg
P 310 701 G NPT	1/4" NPT	1250 l/min	2 - 10 bar	the same	0,14 kg
P 311 701 G NPT	1/4" NPT	1250 l/min	1 - 10 bar	3 - 10 bar	0,14 kg

P 320 302/P 320 502 P 322 302/P 322 502

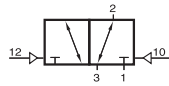

P 320 302
P 320 502

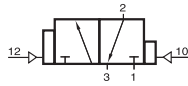

P 322 302
P 322 502

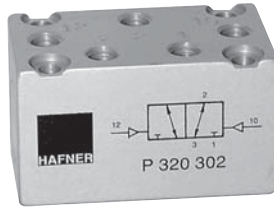

Pneumatically actuated 3/2-way spool valve actuated by impulse.

Type P 320 ___ double pilot

Type P 322 ___ double pilot dominating at port 12

If signal is applied to 12 the valve is open from 1 to 2 and 3 is blocked.

If signal is applied at 10 the valve is open from 2 to 3.

Position is kept until next pneumatic signal is applied.

Exhaust can be throttled.

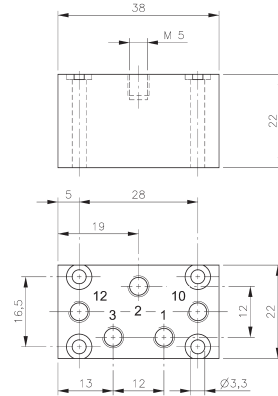

P 320 302/P 322 302

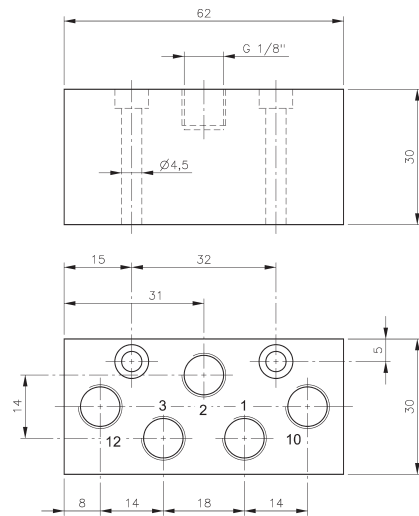

P 320 502/P 322 502

Type	Port size	Air flow	Operating press.	Actuating press.	Weight
P 320 302	M5	180 l/min	1 - 10 bar	2,5 - 10 bar	0,05 kg
P 320 502	G 1/8"	650 l/min	1 - 10 bar	2,5 - 10 bar	0,13 kg
P 322 302	M5	180 l/min	1 - 10 bar	2,5 - 10 bar	0,05 kg
P 322 502	G 1/8"	650 l/min	1 - 10 bar	2,5 - 10 bar	0,13 kg

P 320 501/P 320 701 G/ P 320 801 P 322 501/P 322 701 G

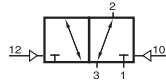

P 320 501
P 320 701 G
P 320 801

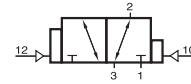

P 322 501
P 322 701 G

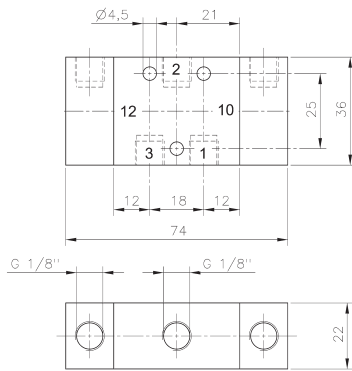

P 320 501/P 322 501

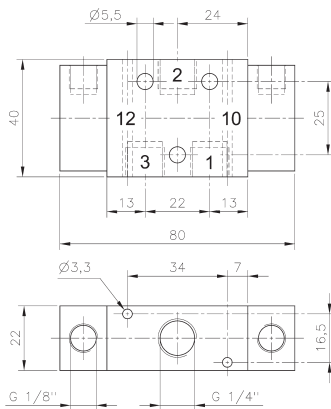
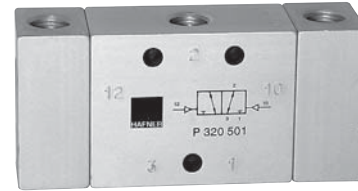

P 320 701 G/P 322 701 G

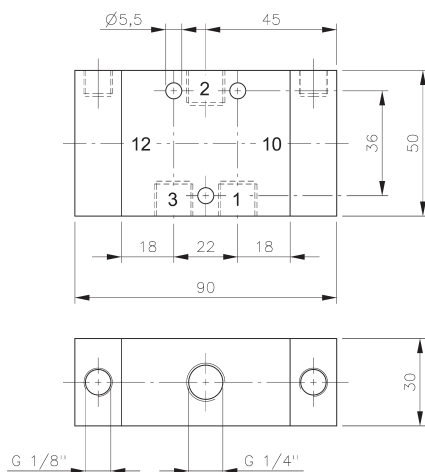

P 320 801

Pneumatically actuated 3/2-way spool valve actuated by impulse.

- Type P 320 ___ double pilot
 - Type P 322 ___ double pilot dominating at port 12
 - Type P 3 __ 701 G dual use, in-line and on manifold.
- Plates are displayed on page 2.7.1.4.

If signal is applied to 12 the valve is open from 1 to 2 and 3 is blocked.

If signal is applied at 10 the valve is open from 2 to 3.

Position is kept until next pneumatic signal is applied.

Operating pressure can also be applied to 2.

Exhaust can be throttled.

Type	Port size	Air flow	Operating press.	Actuating press.	Weight
P 320 501	G 1/8"	650 l/min	1 - 10 bar	2,5 - 10 bar	0,16 kg
P 322 501	G 1/8"	650 l/min	1 - 10 bar	2,5 - 10 bar	0,16 kg
P 320 701 G	G 1/4"	1250 l/min	1 - 10 bar	2,5 - 10 bar	0,17 kg
P 322 701 G	G 1/4"	1250 l/min	1 - 10 bar	2,5 - 10 bar	0,17 kg
P 320 801	G 1/4"	1450 l/min	1 - 10 bar	2,5 - 10 bar	0,34 kg



P 320 101/P 320 121/P 320 181

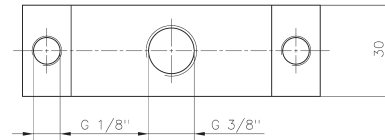
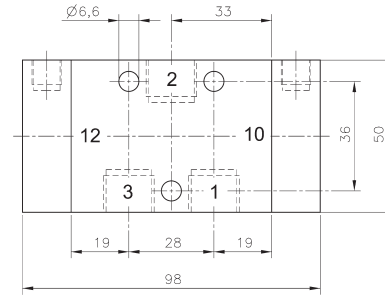
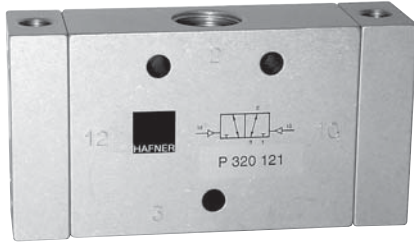
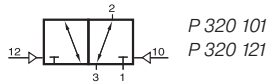

P 320 101

Pneumatically actuated 3/2-way spool valve actuated by impulse.

If signal is applied to 12 the valve is open from 1 to 2 and 3 is blocked.

If signal is applied at 10 the valve is open from 2 to 3.

Operating pressure can also be applied to 2.

Position is kept until next pneumatic signal is applied.

Exhaust can be throttled.

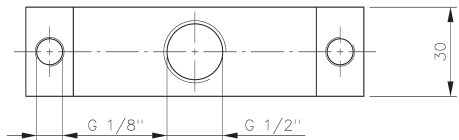
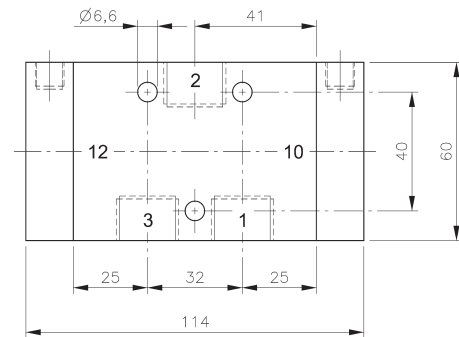

P 320 121

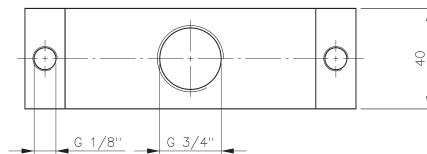
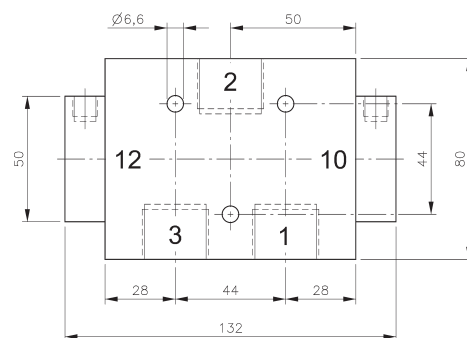

P 320 181

Type	Port size	Air flow	Operating press.	Actuating press.	Weight
P 320 101	G 3/8"	2250 l/min	1 - 10 bar	2,5 - 10 bar	0,38 kg
P 320 121	G 1/2"	3000 l/min	1 - 10 bar	2,5 - 10 bar	0,52 kg
P 320 181	G 3/4"	6000 l/min	1 - 10 bar	2 - 10 bar	0,88 kg

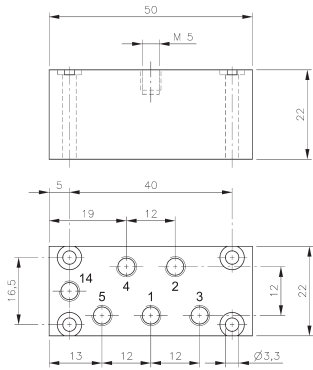
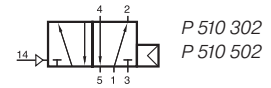

P 510 302

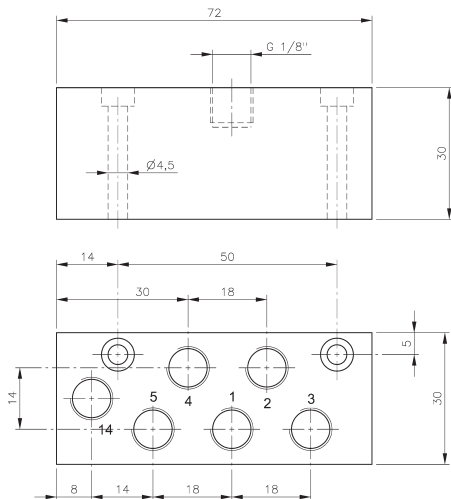

P 510 502

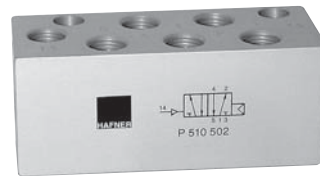

Pneumatically actuated 5/2-way spool valve actuated by permanent signal and equipped with air spring return.

Normally open from 1 to 2 and from 4 to 5. If pressure is applied at 14 the valve is open from 1 to 4 and 2 to 3.

Operating pressure and actuating pressure should be at the same level.

Exhaust can be throttled.

Type	Port size	Air flow	Operating press.	Actuating press.	Weight
P 510 302	M5	180 l/min	2 - 10 bar	the same	0,07 kg
P 510 502	G 1/8"	650 l/min	2 - 10 bar	the same	0,17 kg



P 510 501/P 510 701/P 510 801 P 511 501/P 511 701/P 511 801

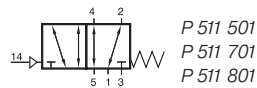
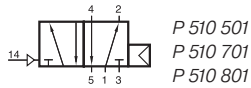

Pneumatically actuated 5/2-way spool valve.

Type P 510 ___ with air-spring-return.
Operating pressure and actuating pressure should be at the same level.

Type P 511 ___ with mechanical spring return.

Normally open from 1 to 2 and from 4 to 5.
If pressure is applied at 14 the valve is open from 1 to 4 and 2 to 3.

Exhaust can be throttled.

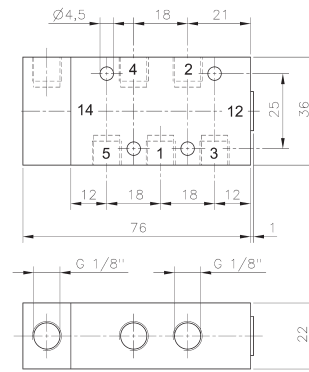

P 510 501/P 511 501

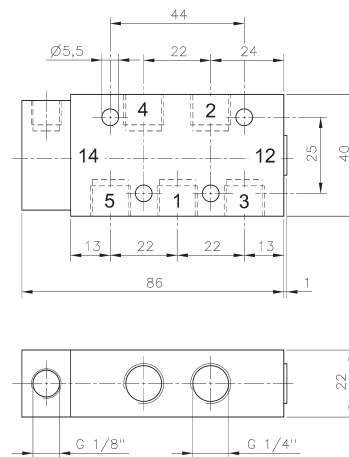

P 510 701/P 511 701

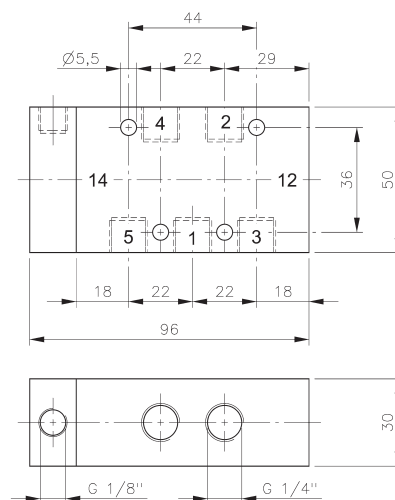

P 510 801/P 511 801

Type	Port size	Air flow	Operating press.	Actuating press.	Weight
P 510 501	G 1/8"	650 l/min	2 - 10 bar	the same	0,16 kg
P 510 701	G 1/4"	1250 l/min	2 - 10 bar	the same	0,18 kg
P 510 801	G 1/4"	1450 l/min	1,5 - 10 bar	the same	0,38 kg
P 511 501	G 1/8"	650 l/min	1 - 10 bar	3 - 10 bar	0,16 kg
P 511 701	G 1/4"	1250 l/min	1 - 10 bar	3 - 10 bar	0,18 kg
P 511 801	G 1/4"	1450 l/min	1 - 10 bar	3 - 10 bar	0,38 kg



P 510 101/P 510 121/P 510 181 P 511 101/P 511 121/P 511 181

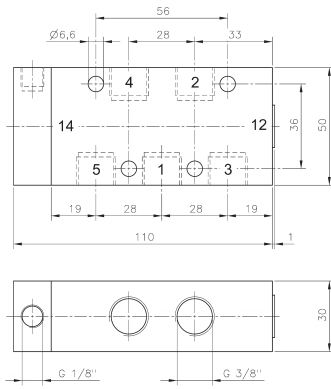

P 510 101/P 511 101

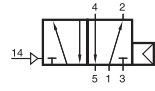

P 510 101
P 510 121
P 510 181
P 510 121 NPT

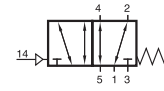

P 511 101
P 511 121
P 511 181
P 511 121 NPT

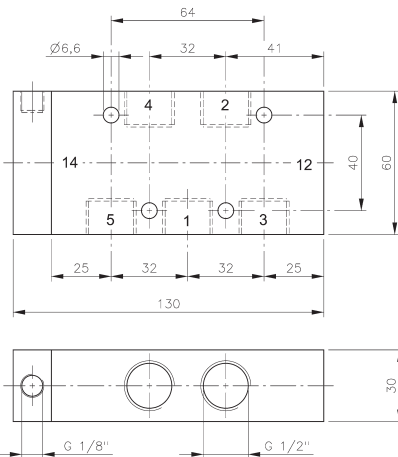
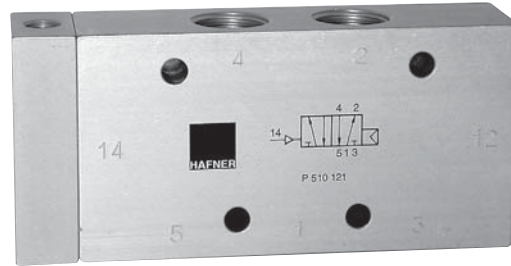

**P 510 121/P 511 121
P 510 121 NPT/P511 121 NPT**

Pneumatically actuated 5/2-way spool valve.

Type P 510 ___ with air-spring-return.
Operating pressure and actuating pressure should be at the same level.

Type P 511 ___ with mechanical spring return.

Normally open from 1 to 2 and from 4 to 5.
If pressure is applied at 14 the valve is open from 1 to 4 and 2 to 3.

Exhaust can be throttled.

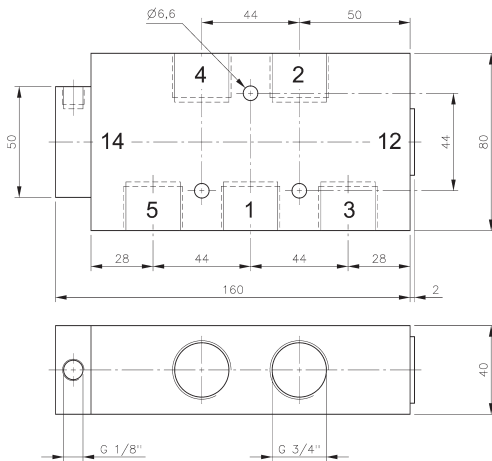

P 510 181/P 511 181

Type	Port size	Air flow	Operating press.	Actuating press.	Weight
P 510 101	G 3/8"	2250 l/min	1,5 - 10 bar	the same	0,42 kg
P 510 121	G 1/2"	3000 l/min	1 - 10 bar	the same	0,59 kg
P 510 181	G 3/4"	6000 l/min	1 - 10 bar	the same	1,18 kg
P 511 101	G 3/8"	2250 l/min	1 - 10 bar	3 - 10 bar	0,42 kg
P 511 121	G 1/2"	3000 l/min	1 - 10 bar	3 - 10 bar	0,59 kg
P 511 181	G 3/4"	6000 l/min	1 - 10 bar	3 - 10 bar	1,18 kg
P 510 121 NPT	1/2" NPT	3000 l/min	1 - 10 bar	the same	0,59 kg
P 511 121 NPT	1/2" NPT	3000 l/min	1 - 10 bar	3 - 10 bar	0,59 kg

P 510 501 G/P 510 701 G/P 510 121 G P 511 501 G/P 511 701 G/P 511 121 G

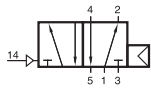

P 510 501 G
P 510 701 G
P 510 121 G
P 510 701 G NPT

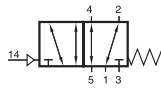

P 511 501 G
P 511 701 G
P 511 121 G
P 511 701 G NPT

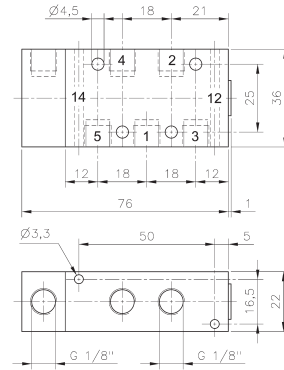
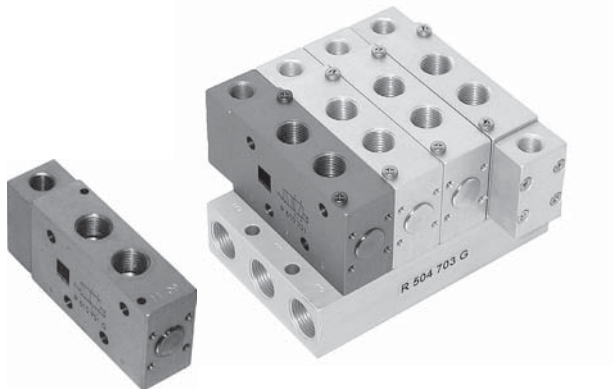

P 510 501 G/P 511 501 G

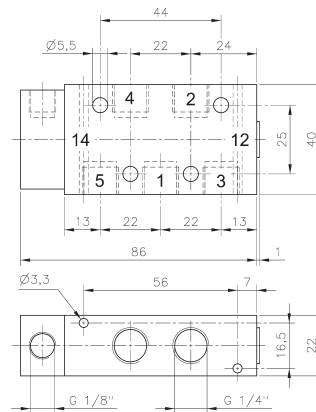

**P 510 701 G/P 511 701 G
P 501 701 G NPT/P 511 701 G NPT**

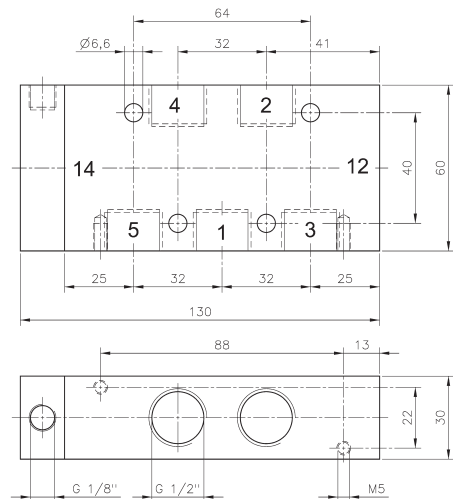

P 510 121 G/P 511 121 G

Pneumatically actuated 5/2-way spool valve.

Type P 510 ___ with air-spring-return.
Operating pressure and actuating pressure should be at the same level.

Type P 511 ___ with mechanical spring return.

Normally open from 1 to 2 and from 4 to 5.
If pressure is applied at 14 the valve is open from 1 to 4 and 2 to 3.

Valves can either be used in-line or on a manifold plate. Manifolds for valves type 501 G are displayed on page 2.7.2.2, manifolds for valves type 701 G are displayed on page 2.7.2.3, manifolds for valves type 121 G are displayed on page 2.7.2.5.

Take into consideration, that G 1/2" valves have to be assembled onto the plate by fixing screws from the bottom through the plate into the valve.

Exhaust can be throttled.

Type	Port size	Air flow	Operating press.	Actuating press.	Weight
P 510 501 G	G 1/8"	650 l/min	2 - 10 bar	the same	0,16 kg ❄️
P 510 701 G	G 1/4"	1250 l/min	2 - 10 bar	the same	0,18 kg ❄️
P 510 121 G	G 1/2"	3000 l/min	1 - 10 bar	the same	0,59 kg
P 511 501 G	G 1/8"	650 l/min	1 - 10 bar	3 - 10 bar	0,16 kg ❄️
P 511 701 G	G 1/4"	1250 l/min	1 - 10 bar	3 - 10 bar	0,18 kg ❄️
P 511 121 G	G 1/2"	3000 l/min	1 - 10 bar	3 - 10 bar	0,59 kg
P 510 701 G NPT	1/4" NPT	1250 l/min	2 - 10 bar	the same	0,18 kg
P 511 701 G NPT	1/4" NPT	1250 l/min	1 - 10 bar	3 - 10 bar	0,18 kg

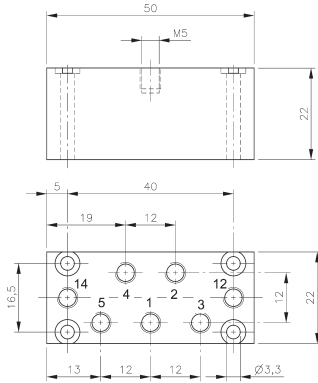
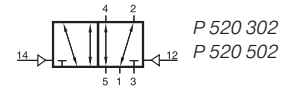

P 520 302

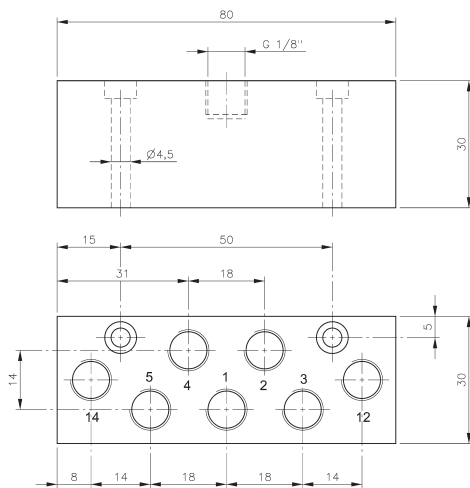

P 520 502



Pneumatically actuated 5/2-way spool valve actuated by impulse.

If signal is applied to 14 the valve is open from 1 to 4 and 2 to 3, 5 is closed.

If signal is applied to 12 the valve is open from 1 to 2 and 4 to 5.

Position is kept until next pneumatic signal is applied.

Exhaust can be throttled.

Type	Port size	Air flow	Operating press.	Actuating press.	Weight
P 520 302	M5	180 l/min	1 - 10 bar	2,5 - 10 bar	0,07 kg
P 520 502	G 1/8"	650 l/min	1 - 10 bar	2,5 - 10 bar	0,17 kg



P 520 501/P 520 701/P 520 801 P 522 501/P 522 701

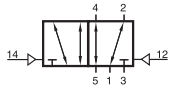

P 520 501
P 520 701
P 520 801

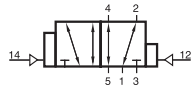

P 522 501
P 522 701

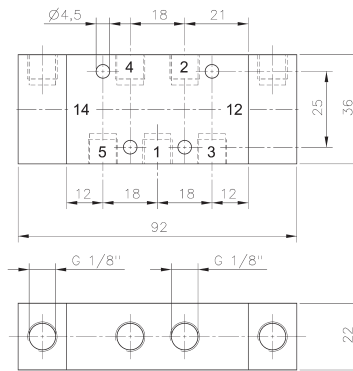
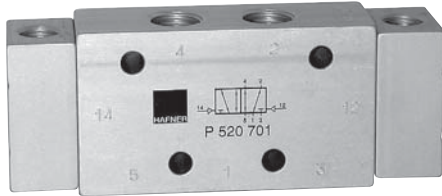

P 520 501/P 522 501

Pneumatically actuated 5/2-way spool valve.

Type P 520 ___ double pilot

Type P 522 ___ double pilot dominating at port 14

If signal is applied to 14 the valve is open from 1 to 4 and 2 to 3, 5 is closed.

If signal is applied to 12 the valve is open from 1 to 2 and 4 to 5.

Position is kept until next pneumatic signal is applied.

Exhaust can be throttled.

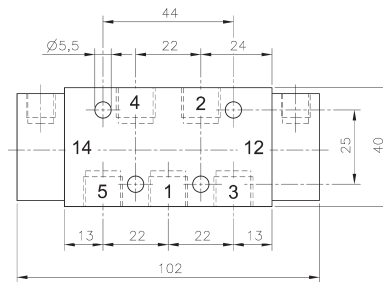

P 520 701/ P 522 701

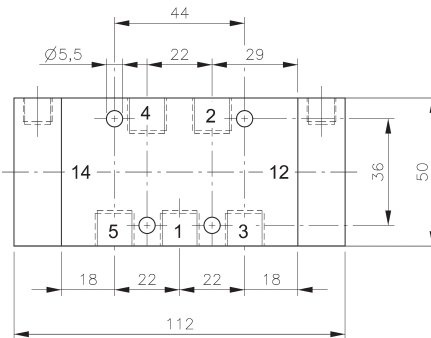
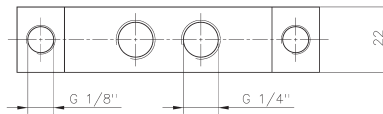

P 520 801

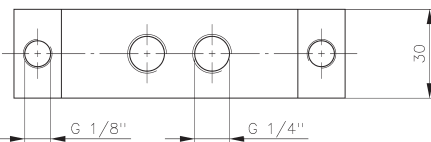

Type	Port size	Air flow	Operating press.	Actuating press.	Weight	
P 520 501	G 1/8"	650 l/min	1 - 10 bar	2,5 - 10 bar	0,20 kg	Ex
P 522 501	G 1/8"	650 l/min	1 - 10 bar	2,5 - 10 bar	0,20 kg	
P 520 701	G 1/4"	1250 l/min	1 - 10 bar	2,5 - 10 bar	0,22 kg	Ex
P 522 701	G 1/4"	1250 l/min	1 - 10 bar	2,5 - 10 bar	0,22 kg	
P 520 801	G 1/4"	1450 l/min	1 - 10 bar	2,5 - 10 bar	0,44 kg	Ex

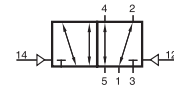

P 520 101
P 520 121
P 520 181
P 520 121 NPT

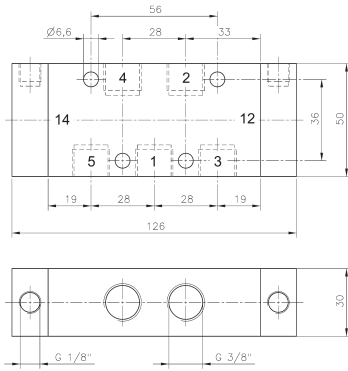

P 520 101

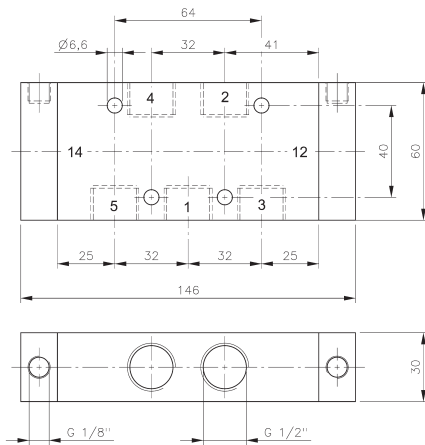

P 520 121/P 520 121 NPT

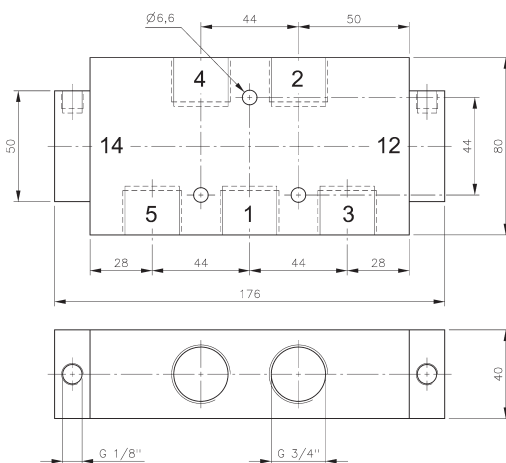

P 520 181

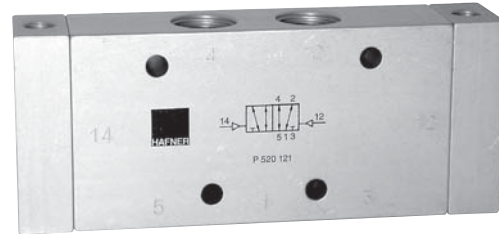

Pneumatically actuated 5/2-way spool valve actuated by impulse.

If signal is applied to 14 the valve is open from 1 to 4 and 2 to 3, 5 is closed.

If signal is applied to 12 the valve is open from 1 to 2 and 4 to 5.

Position is kept until next pneumatic signal is applied.

Exhaust can be throttled.

Type	Port size	Air flow	Operating press.	Actuating press.	Weight
P 520 101	G 3/8"	2250 l/min	1 - 10 bar	2,5 - 10 bar	0,48 kg
P 520 121	G 1/2"	3000 l/min	1 - 10 bar	2,5 - 10 bar	0,67 kg
P 520 181	G 3/4"	6000 l/min	1 - 10 bar	2 - 10 bar	1,22 kg
P 520 121 NPT	1/2" NPT	3000 l/min	1 - 10 bar	2,5 - 10 bar	0,67 kg



P 520 501 G/P 520 701 G/P 520 121 G P 522 501 G/P 522 701 G

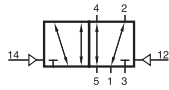

P 520 501 G
P 520 701 G
P 520 121 G
P 520 701 G NPT

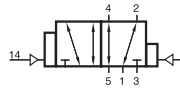

P 522 501 G
P 522 701 G

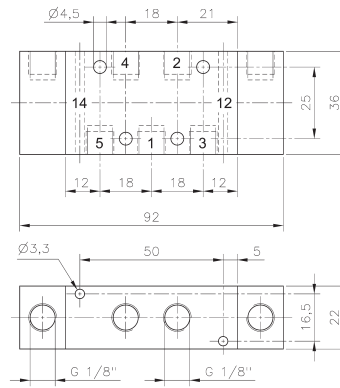
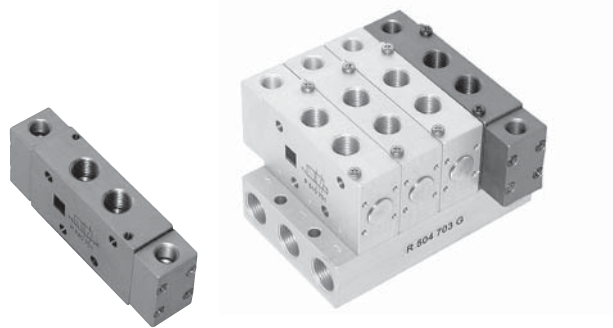

P 520 501 G/P 522 501 G

Pneumatically actuated 5/2-way spool valve.

Type P 520 ___ double pilot

Type P 522 ___ double pilot dominating at port 14

If signal is applied to 14 the valve is open from 1 to 4 and 2 to 3, 5 is closed.

If signal is applied to 12 the valve is open from 1 to 2 and 4 to 5.

Position is kept until next pneumatic signal is applied.

Valves can either be used in-line or on a manifold plate. Manifolds for valves type 501 G are displayed on page 2.7.2.2, manifolds for valves type 701 G are displayed on page 2.7.2.3, manifolds for valves type 121 G are displayed on page 2.7.2.5.

Take into consideration, that G 1/2" valves have to be assembled onto the plate by fixing screws from the bottom through the plate into the valve.

Exhaust can be throttled.

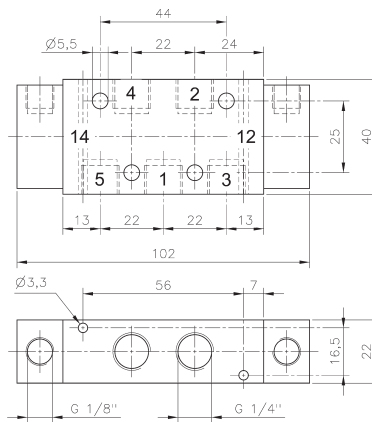

**P 520 701 G/P 522 701 G
P 520 701 G NPT**

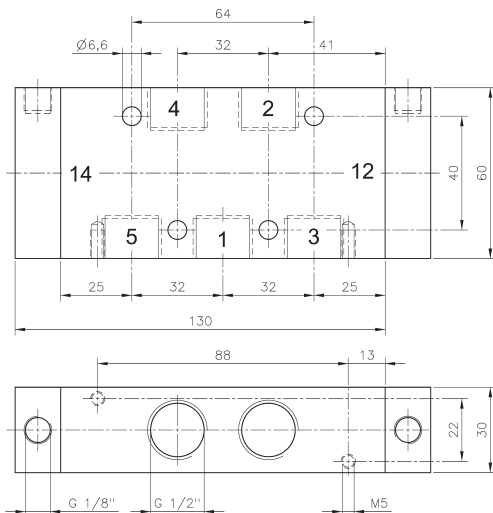

P 520 121 G

Type	Port size	Air flow	Operating press.	Actuating press.	Weight
P 520 501 G	G 1/8"	650 l/min	1 - 10 bar	2,5 - 10 bar	0,20 kg ❄️
P 522 501 G	G 1/8"	650 l/min	1 - 10 bar	2,5 - 10 bar	0,20 kg
P 520 701 G	G 1/4"	1250 l/min	1 - 10 bar	2,5 - 10 bar	0,22 kg ❄️
P 522 701 G	G 1/4"	1250 l/min	1 - 10 bar	2,5 - 10 bar	0,22 kg
P 520 121 G	G 1/2"	3000 l/min	1 - 10 bar	2,5 - 10 bar	0,67 kg
P 520 701 G NPT	1/4" NPT	1250 l/min	1 - 10 bar	2,5 - 10 bar	0,22 kg

P 53_ 501/P 53_ 701/P 53_ 801

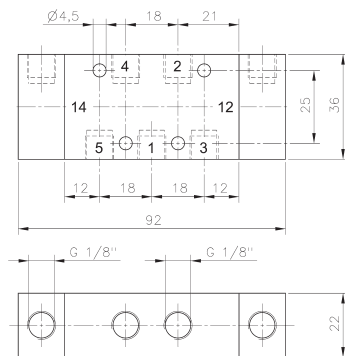
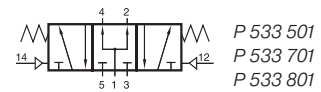
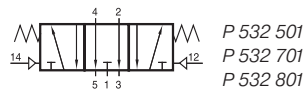
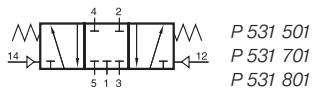

P 53_ 501

Pneumatically actuated 5/3-way spool valve with spring return to middle position.

- Type 531 centre closed
- Type 532 centre exhausted
- Type 533 centre pressurised

When ordering please complete the type number by 1, 2 or 3 according to the type required.

Exhaust can be throttled.

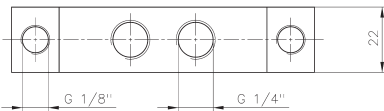
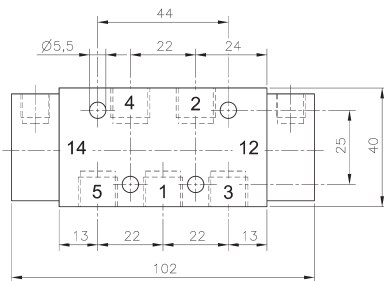

P 53_ 701

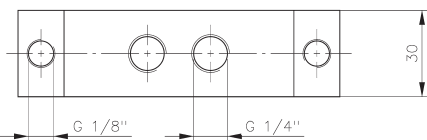
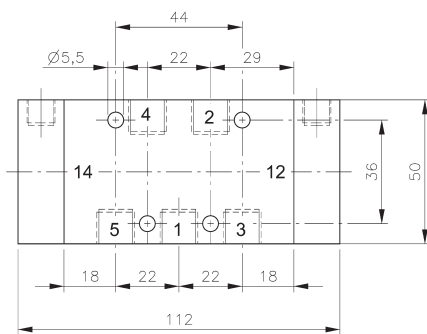

P 53_ 801

Type	Port size	Air flow	Operating press.	Actuating press.	Weight
P 53_ 501	G 1/8"	650 l/min	1 - 10 bar	3 - 10 bar	0,20 kg
P 53_ 701	G 1/4"	1250 l/min	1 - 10 bar	3 - 10 bar	0,22 kg
P 53_ 801	G 1/4"	1450 l/min	1 - 10 bar	3 - 10 bar	0,44 kg

P 53_ 101/P 53_ 121/P 53_ 181

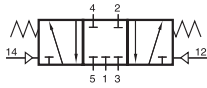

P 531 101
P 531 121
P 531 181
P 531 121 NPT

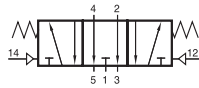

P 532 101
P 532 121
P 532 181
P 532 121 NPT

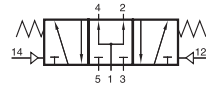

P 533 101
P 533 121
P 533 181
P 533 121 NPT

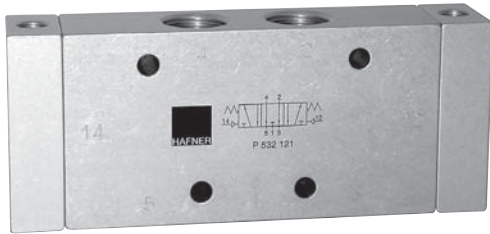

Pneumatically actuated 5/3-way spool valve with spring return to middle position.

- Type 531 centre closed
- Type 532 centre exhausted
- Type 533 centre pressurised

When ordering please complete the type number by 1, 2 or 3 according to the type required.

Exhaust can be throttled.

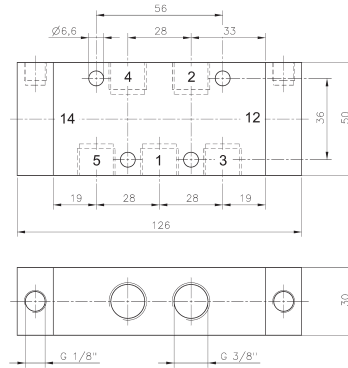

P 53_ 101

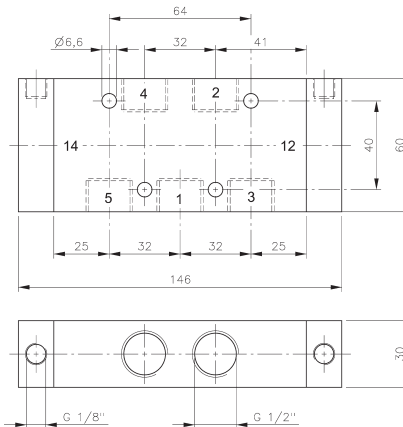

P 53_ 121/P 53_ 121 NPT

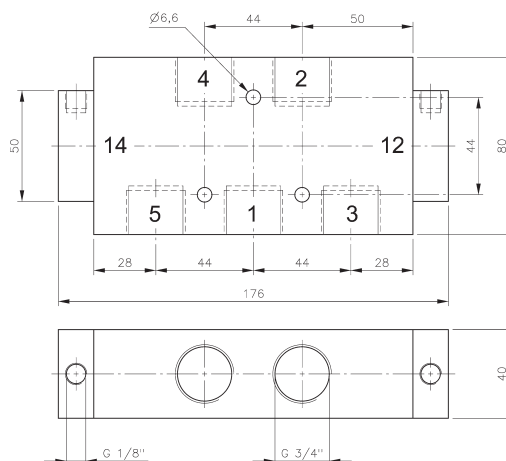

P 53_ 181

Type	Port size	Air flow	Operating press.	Actuating press.	Weight
P 53_ 101	G 3/8"	2250 l/min	1 - 10 bar	3 - 10 bar	0,49 kg
P 53_ 121	G 1/2"	3000 l/min	1 - 10 bar	3 - 10 bar	0,69 kg
P 53_ 181	G 3/4"	6000 l/min	1 - 10 bar	3 - 10 bar	1,22 kg
P 53_ 121 NPT	1/2" NPT	3000 l/min	1 - 10 bar	3 - 10 bar	0,69 kg

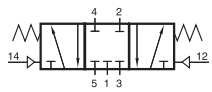

P 531 501 G
P 531 701 G
P 531 121 G
P 531 701 G NPT

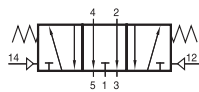

P 532 501 G
P 532 701 G
P 532 121 G
P 532 701 G NPT

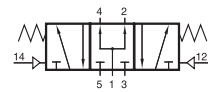

P 533 501 G
P 533 701 G
P 533 121 G
P 533 701 G NPT

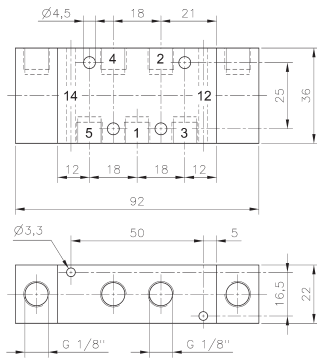

P 53_ 501 G

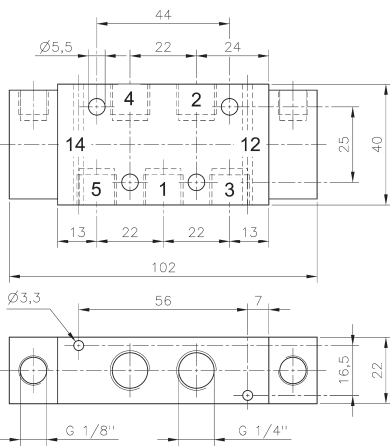

P 53_ 701 G/P 53_ 701 G NPT

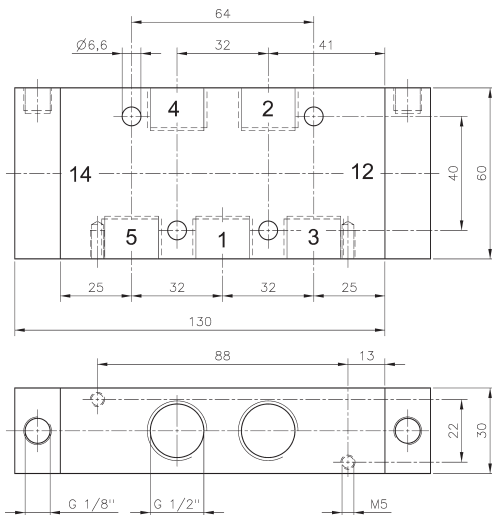

P 53_ 121 G

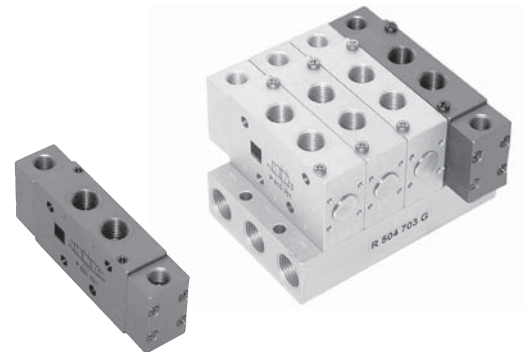

Pneumatically actuated 5/3-way spool valve with spring return to middle position.

- Type 531 centre closed
- Type 532 centre exhausted
- Type 533 centre pressurised

When ordering please complete the type number by 1, 2 or 3 according to the type in need.

Valves can either be used in-line or on a manifold plate. Manifolds for valves type 501 G are displayed on page 2.7.2.2, manifolds for valves type 701 G are displayed on page 2.7.2.3, manifolds for valves type 121 G are displayed on page 2.7.2.5.

Take into consideration, that G 1/2" valves have to be assembled onto the plate by fixing screws from the bottom through the plate into the valve.

Exhaust can be throttled.

Type	Port size	Air flow	Operating press.	Actuating press.	Weight
P 53_ 501 G	G 1/8"	650 l/min	1 - 10 bar	3 - 10 bar	0,20 kg
P 53_ 701 G	G 1/4"	1250 l/min	1 - 10 bar	3 - 10 bar	0,22 kg
P 53_ 121 G	G 1/2"	3000 l/min	1 - 10 bar	3 - 10 bar	0,69 kg
P 53_ 701 G NPT	1/4" NPT	1250 l/min	1 - 10 bar	3 - 10 bar	0,22 kg



VA 341/VA 401 ES 341/ES 401



VA 341/VA 401: OR-gate

The OR-gate has two inputs 1 and one output 2.

The shuttle valve is used when only one of two possible signals is required to pass on a signal.

Function: If one of two signal inputs are activated, an output signal on port 2 is present and the other input is blocked.

In case of pressurising both inputs at different pressure levels, the higher pressure is fed to port 2.

ES 341/ES 401: AND-gate

The AND-gate has two inputs 1 and one output 2.

The dual-pressure valve is used when at least 2 signals are required before a signal is passed on.

Function: Only when both inputs are pressurised output 2 is pressurised.

If two different pressures are applied the lower pressure is fed to output 2.

In case of only one signal at one of the two ports 1, the output 2 is blocked.

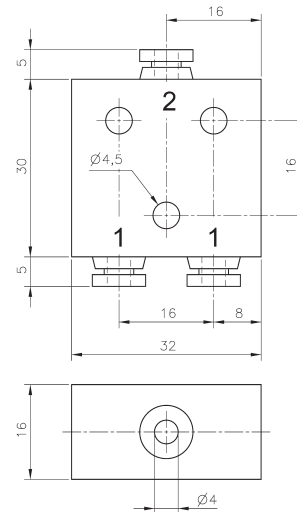

VA 341/ES 341

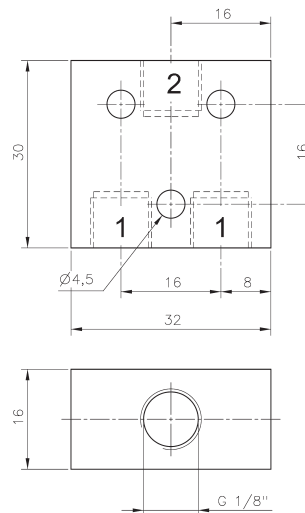

VA 401/ES 401

Type	Function	Port size	Air flow	Operating press.	Weight
VA 341	OR	pif 4 mm	280 l/min	1 - 10 bar	0,04 kg
VA 401	OR	G 1/8"	280 l/min	1 - 10 bar	0,04 kg
ES 341	AND	pif 4 mm	280 l/min	1 - 10 bar	0,04 kg
ES 401	AND	G 1/8"	280 l/min	1 - 10 bar	0,04 kg

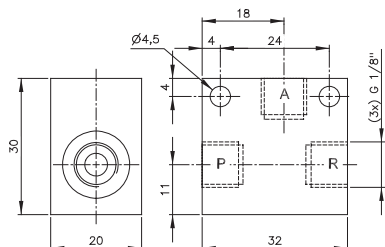
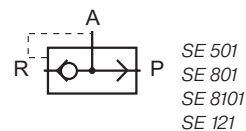

SE 501



Quick-exhaust valve which can also be used as non-return valve as well as or-gate.

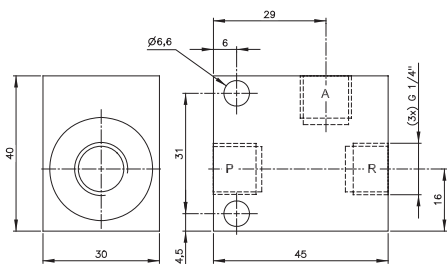

SE 801

If used as a non-return valve please plug port R. Open from P to A, closed from A to P.

If used as an or-gate connect pressure to P and R. Port A is outlet.

Temperature range: -20° C to +80° C

Stainless steel version as well as low temperature version (-40° C) available on request.

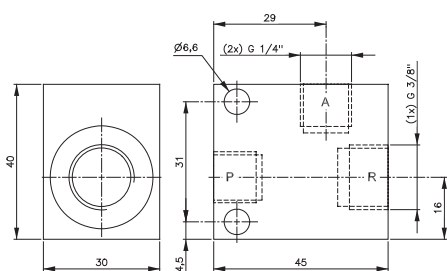

SE 8101

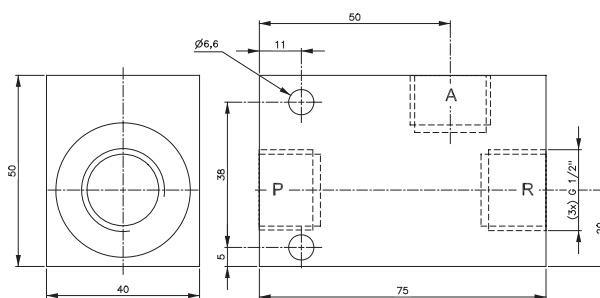

SE 121

Type	Port size A + P	Port size R	Air flow from A to R	Operating press.	Weight
SE 501	G 1/8"	G 1/8"	564 l/min	0,3 - 10 bar	0,06 kg
SE 801	G 1/4"	G 1/4"	1188 l/min	0,2 - 10 bar	0,18 kg
SE 8101	G 1/4"	G 3/8"	1188 l/min	0,2 - 10 bar	0,18 kg
SE 121	G 1/2"	G 1/2"	3600 l/min	0,5 - 10 bar	0,26 kg



P 311 501 SR/P 411 701 SR P 411 701 SR NPT

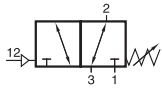

P311 501 SR

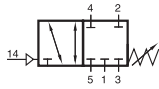

P 411 701 SR
P 411 701 SR NPT



P 311 501 SR pneumatically actuated 3/2-way valve with mechanical spring return. Valve can be used normally closed (pressure at port 1) and normally open (pressure at port 3). Can also be used as 2/2-way valve. Unused port to be closed with a silencer or plug.

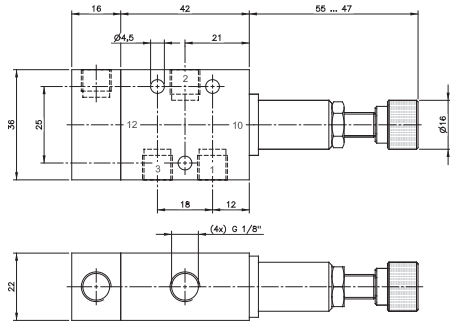

P 311 501 SR

P 411 701 SR pneumatically actuated 4/2-way valve with mechanical spring return. Valve either blocks all ports or is open from 1 to 4 and from 3 to 2. Port 5 is a vent port and should have a silencer installed, do not plug.

Valve can be used as an **adjustable pneumatic pressure switch**. By turning the hand-wheel the required minimum actuation pressure can be set between 3 and 6 bar. Adjustment is not independent from operation pressure.

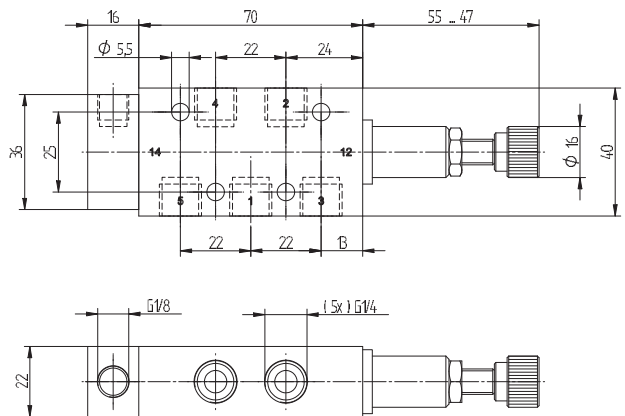

P 411 701 SR/P 411 701 SR NPT

Type	Port size	Air flow	Operating press.	Regulating range act. press.	Max. act. press.	Weight
P 311 501 SR	G 1/8"	650 l/min	2 - 10 bar	3 - 6 bar	10 bar	0,16 kg
P 411 701 SR	G 1/4"	1250 l/min	2 - 10 bar	3 - 6 bar	10 bar	0,21 kg
P 411 701 SR NPT	1/4" NPT	1250 l/min	2 - 10 bar	3 - 6 bar	10 bar	0,21 kg

DR 501/DR 801/DR 101 D 501/D 801/D 101

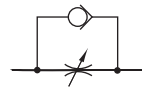

DR 501
DR 801
DR 101



D 501
D 801
D 101

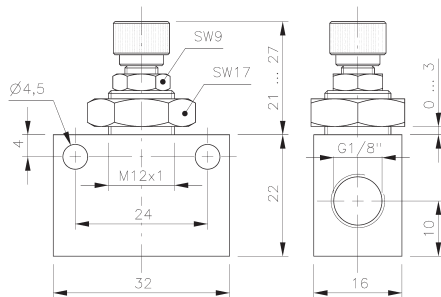

DR 501/D 501

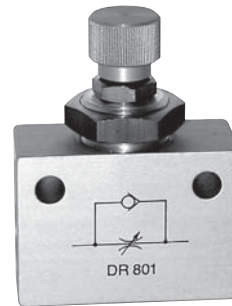

Block form flow regulator.

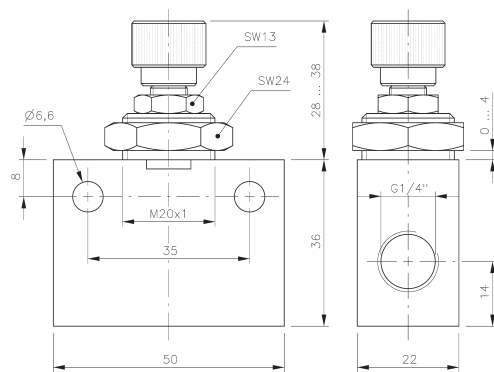

DR 801/D 801

Type DR

uni-directional block form flow regulator.

Air streaming in the direction of the throttle can be regulated by turning the spindle. In the opposite direction air streams unthrottled.

Type D

bi-directional flow regulator. Air is regulated in both directions.

The throttle can be adjusted very precisely along the entire regulation range.

Adjustment can be locked.

Suitable for wall and panel mounting.

Nut is included.

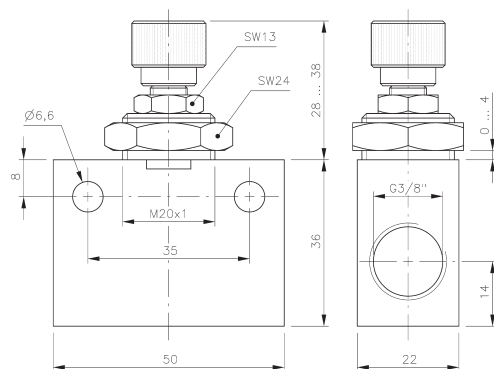

DR 101/D 101

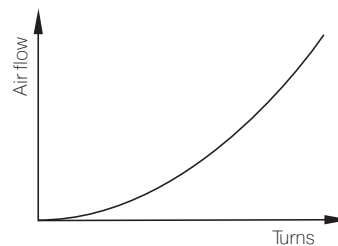

Type	Port size	Air flow	Airflow in opposite direction	Operating press.	Weight
D 501	G 1/8"	450 l/min	450 l/min	0,5 - 10 bar	0,04 kg
D 801	G 1/4"	1150 l/min	1150 l/min	0,5 - 10 bar	0,13 kg
D 101	G 3/8"	1450 l/min	1450 l/min	0,5 - 10 bar	0,13 kg
DR 501	G 1/8"	450 l/min	450 l/min	2 - 10 bar	0,04 kg
DR 801	G 1/4"	1150 l/min	1150 l/min	2 - 10 bar	0,13 kg
DR 101	G 3/8"	1450 l/min	1450 l/min	2 - 10 bar	0,13 kg

P 310 304/P 311 304 P 320 304/P 322 304/RP 3 344

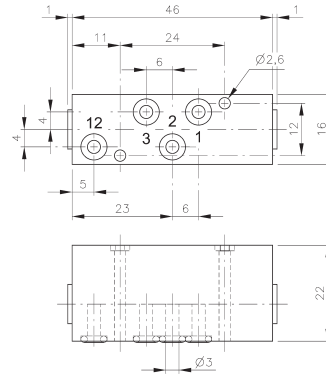
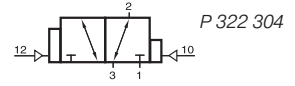
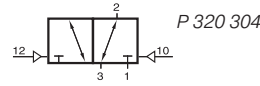
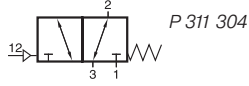
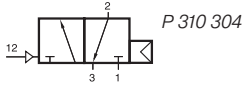

P 310 304/P 311 304

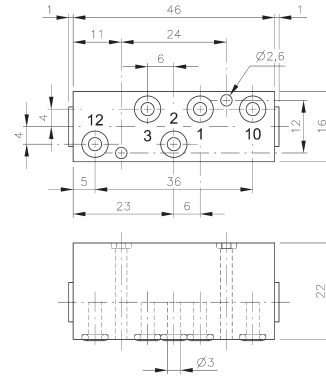

P 320 304/P 322 304

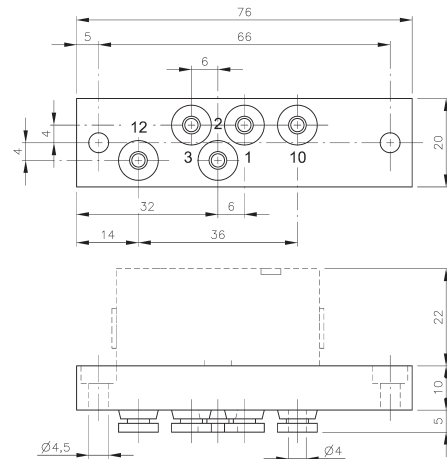

RP 3 344

Pneumatically actuated 3/2-way spool valves.
To be assembled to plate RP 3 344.

Four different versions are offered:

- P 310 304 valve with air-spring return.
- P 311 304 valve with mechanical spring return.
- P 320 304 double pilot valve
- P 322 304 double pilot valve dominating at port 12.

For P 310 304 the operating and actuating pressure should be at the same level.

RP 3 344 is designed for carrying one 3/2-way valve type P 310 304, P 311 304, P 320 304 or P 322 304. The plate is equipped with 5 push-in fittings for 4 mm tube.

Type	Port size	Air flow	Operating press.	Actuating press	Weight
P 310 304	Ø 3 mm	280 l/min	2 - 10 bar	the same	0,04 kg
P 311 304	Ø 3 mm	280 l/min	2 - 10 bar	3 - 10 bar	0,04 kg
P 320 304	Ø 3 mm	280 l/min	2 - 10 bar	2,5 - 10 bar	0,04 kg
P 322 304	Ø 3 mm	280 l/min	2 - 10 bar	2,5 - 10 bar	0,04 kg
RP 3 344	pif 4 mm				0,04 kg

P 510 304/P 511 304 P 520 304/P 522 304/RP 5 344

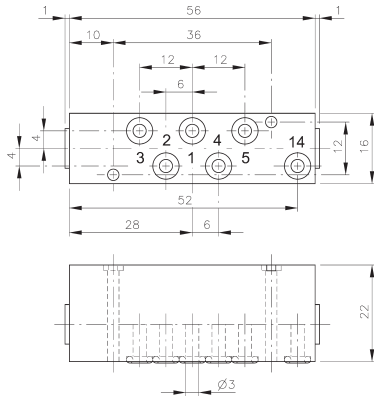
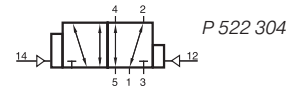
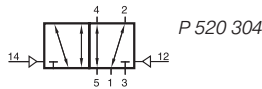
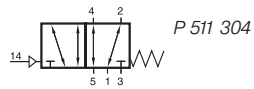
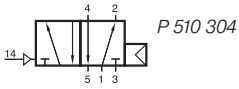

P 510 304/P 511 304

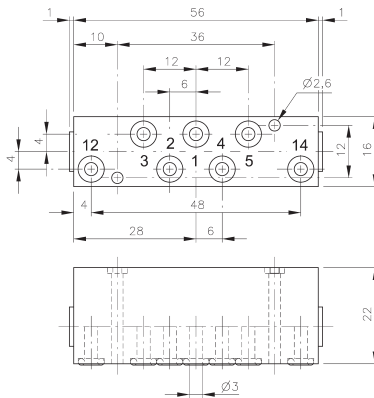

P 520 304/P 522 304

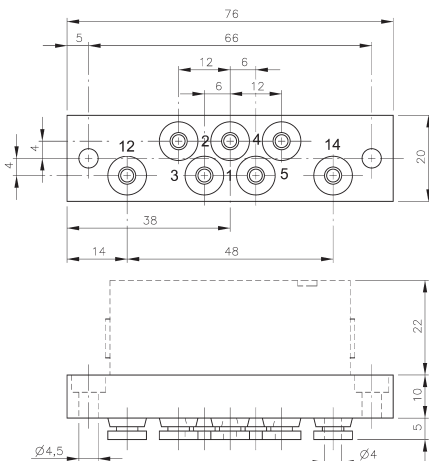

RP 5 344



Pneumatically actuated 5/2-way spool valves.
To be assembled to plate RP 5 344.

Four different versions are offered:

- P 510 304 valve with air-spring return.
- P 511 304 valve with mechanical spring return.
- P 520 304 double pilot valve
- P 522 304 double pilot valve dominating at port 14.

5/3-way valves are available on request.

For P 510 304 the operating and actuating pressure should be at the same level.

RP 5 344 is designed for carrying one piece 5-way valve type P 510 304, P 511 304, P 520 304 or P 522 304.

3/2-way valves can also be assembled to that plate. The plate is equipped with 7 push-in fittings for 4 mm tube.

Type	Port size	Air flow	Operating press.	Actuating press	Weight
P 510 304	Ø 3 mm	280 l/min	2 - 10 bar	the same	0,06 kg
P 511 304	Ø 3 mm	280 l/min	2 - 10 bar	3 - 10 bar	0,06 kg
P 520 304	Ø 3 mm	280 l/min	2 - 10 bar	2,5 - 10 bar	0,06 kg
P 522 304	Ø 3 mm	280 l/min	2 - 10 bar	2,5 - 10 bar	0,06 kg
RP 5 344	pif 4 mm				0,04 kg

VA 304/ES 304/RP 2 344



VA 304: OR-gate

The OR-gate has two inputs 1 and one output 2.

The shuttle valve is used when only one of two possible signals is required to pass on a signal.

Function: If one of two signal inputs are activated, an output signal on port 2 is present and the other input is blocked.

In case of pressurising both inputs at different pressure levels, the higher pressure is fed to port 2.

ES 304: AND-gate

The AND-gate has two inputs 1 and one output 2.

The dual-pressure valve is used when at least 2 signals are required before a signal is passed on.

Function: Only when both inputs are pressurised output 2 is pressurised.

If two different pressures are applied the lower pressure is fed to output 2.

In case of only one signal at one of the two ports 1, the output 2 is blocked.

Both elements can be assembled to RP 2 344. Plate can carry 2 pieces AND- or OR-gates. Both types can be mixed on the plate. The plate is equipped with 6 push-in fittings for 4 mm tube.

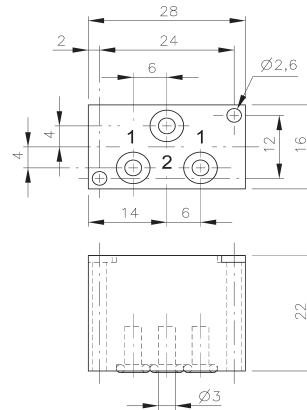

VA 304/ES 304

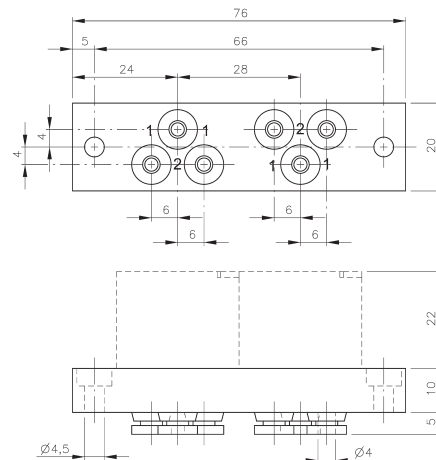

RP 2 344

Type	Function	Port size	Air flow	Operating press.	Weight
VA 304	OR	Ø 3 mm	280 l/min	1 - 10 bar	0,03 kg
ES 304	AND	Ø 3 mm	280 l/min	1 - 10 bar	0,03 kg
RP 2 344	plate	pif 4 mm			0,04 kg