

- 1 Stepless control**
Stepless control of air pressure proportional to an electrical signal.
- High precision pressure control**
Achieve high precision pressure control with microcomputer PID.
- Certification** Comply with IP65 and CE certification.

1 Regulator Performance	
Linearity	±1% less (F.S.)
Hysteresis	±0.5% less (F.S.)
Repeatability	±0.5% less (F.S.)
Sensitivity	±0.2% less (F.S.)

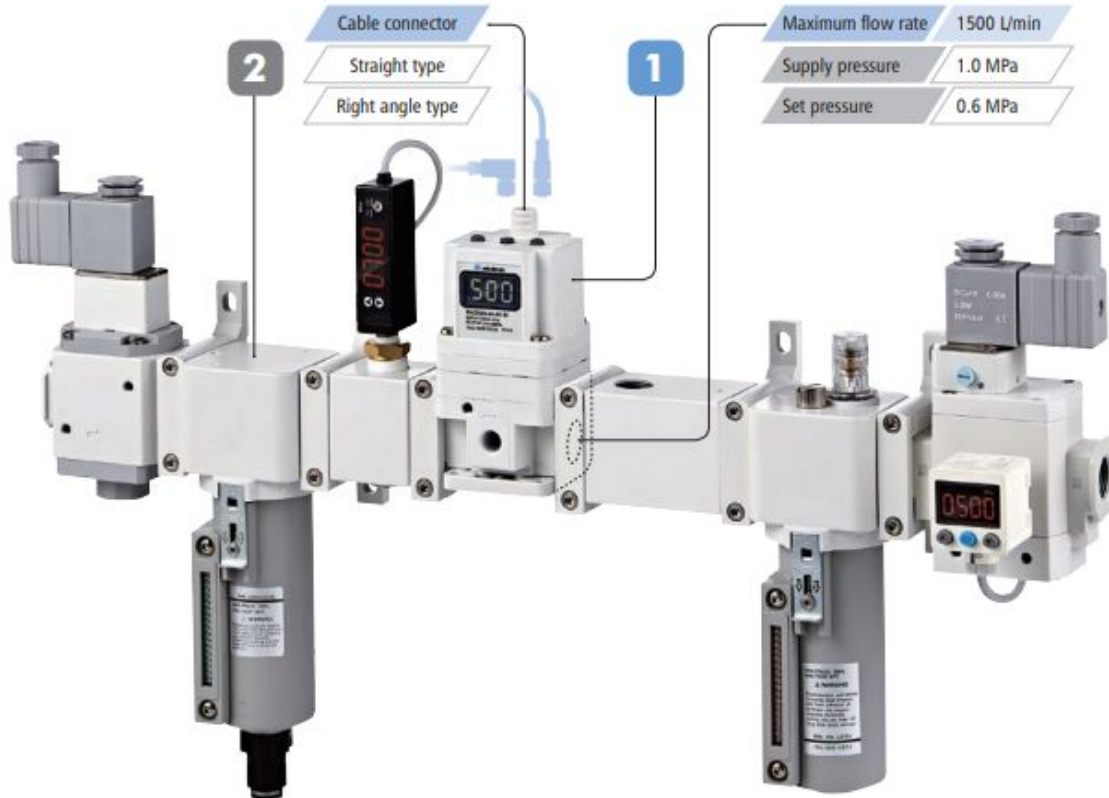

Energy saving piping

Simplify complex pipeline for controlling different pressure.
Space saving, Reduce cost, Energy saving.

VS

Tradition piping

Tradition piping for multi-stage air pressure.

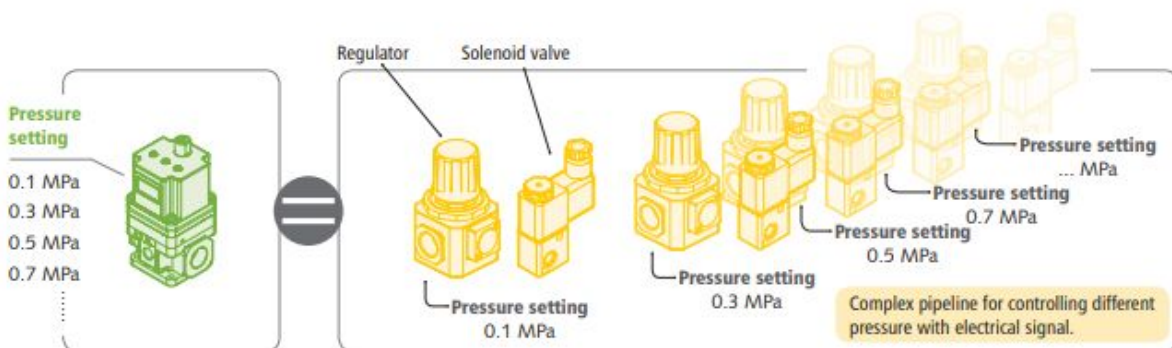

Wiring

Connect the cable to the connector on the body with the wiring arranged as shown below.

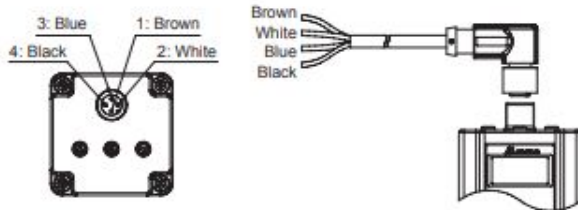

Input signal:

Current, voltage signal type

1	Brown	Power supply
2	White	Input signal
3	Blue	GND(COMMON)
4	Black	Monitor output

Input signal:

Preset input type

1	Brown	Power supply
2	White	Input signal 1
3	Blue	GND(COMMON)
4	Black	Input signal 2

* The cables are available in both straight type and right angle type. A right angle type connector is attached facing left (towards the SUP port). The direction of the straight type arrow is aligned with socket latch.

Warning

- The color of connector pins and cable conductors must be checked when wiring. Check wire color with handling precaution, since improper wire connection leads to destruction/failure and malfunction.
- When the cable plug is connected to the socket of the body, please correctly align the pins with the socket latch, and then slowly lock it downwards.
Do not force to lock, it may damage the cable plug or casing, causing malfunction or abnormality.
- Do not use power voltage exceeding specifications. The product could malfunction or catch fire if voltage exceeding the working range is applied.
- Short-circuiting the load could result in rupture or fire.

Caution

- The connection between the cable plug and the wire is weak. Excessive bending may shorten the life of the plug set, causing breakage or damage.
- If you need an anti-bending cable, please contact the sales.

Wiring diagrams

Connect the cable to the connector on the body with the wiring arranged as shown below.

Current, voltage signal type

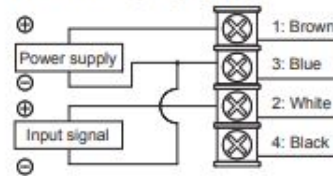

Preset input type

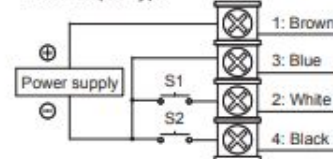

Monitor output wiring diagram

Switch output – NPN type

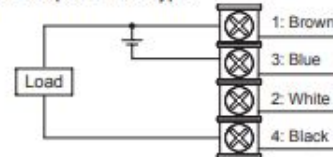

Switch output – PNP type

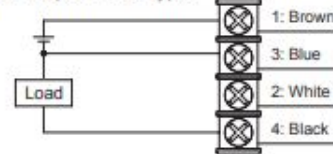

* NPN / PNP output type does not contain overcurrent protection and an error warning display, so the loop current should not exceed 160mA to avoid burning.

DC1~5V Analog output, Voltage type

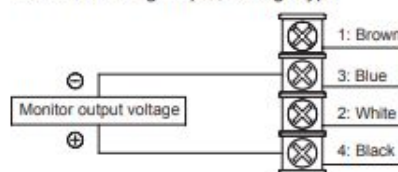

DC4~20mA Analog output, Current type (source type)

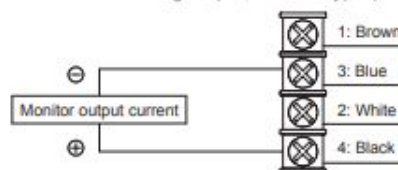

Operating environment

⚠ Caution

- 1 Avoid using this regulator where it will be subject to direct sunlight, water or oil, etc.
- 2 Use in place where the temperature changes drastically or at high humidity may cause damage due to dew condensation in the product.

Air supply

⚠ Caution

- 1 Use clean compressed air that does not contain corrosive gas. Poor air quality adversely affects function and life.
- 2 For the pneumatic source, use cleaned air from which the solid, water and oil contents were eliminated sufficiently, using an air dryer, filter and oil mist filter. Recommend selecting a filtration precision of 5µm or less.
- 3 Do not use a lubricator on the supply side of this product, the lubricated air might cause malfunction. When lubrication of terminal equipment is necessary, connect a lubricator on the output side of the equipment and set a check valve. When the secondary pressure is lowered with an input signal, the secondary air passes through the product and is discharged from the EXH port. Contamination on the secondary piping and the inside of the load will have an adverse effect on performance, etc. Keep the inside of the piping as clean as possible.
- 4 Tighten pipes with the appropriate torque to prevent air leakage and screw damage. First tighten the screw by hand to prevent damage to screw threads, then use a tool.
- 5 Tighten pipes with the appropriate torque. Pipes must be connected with the appropriate torque to prevent air leakages and screw damage. First tighten the screw by hand to prevent damage to screw threads, then use a tool.

Handling

⚠ Caution

- 1 If supply pressure to this product is interrupted while the power is still on, the internal solenoid valve will continue to operate and a humming noise may be generated. Since the life of the product may be shortened, shut off the power supply also when supply pressure is shut off.
- 2 IF electric power is shut off while pressure is being applied, pressure will be retained on the output side. However, this output pressure is held only temporarily and is not guaranteed.
- 3 The product characteristics are confined to no flow in the pipeline. When air is consumed on the output side, pressure may become unstable.
- 4 Refer to the operation manual included with the product for details on its handling.
- 5 When the appliance set standby with 0 kPa input, please input an offset signal of residual pressure. If not, the inner solenoid valve will overaction to cut down the product lifespan.
- 6 Even when pressure is set to 0 MPa, secondary side pressure

will not be completely released with less than 1%F.S. remaining. If precisely 0 MPa is required, bleed the secondary side or install a 3-way valve on the secondary side to switch the secondary side to atmospheric pressure.

⚠ Warning

- 7 Do not use input signal exceeding specifications. This product could malfunction fire if input signal exceeding the working range is applied.
- 8 This product is adjusted for each specification at the time of shipment from the factory. Disassembling and reformation are prohibited, as this way might lead to malfunction.
- 9 If an abnormality occurs during operation, immediately turn off the power and air pressure and stop using it.

Terms

- 1 **Proof pressure:** The value of the maximum pressure that the device can endure and not to malfunction.
- 2 **Setting pressure range:** The range of the controllable pressures. Control is stopped when the input signal becomes 1% F.S. or lower.
Note. This is different from the accuracy guarantee range. See the item of linearity and hysteresis side.
- 3 **Linearity:** The error of the linear output relative to the ideal straight line, i.e. the accuracy of the analog output. It is usually expressed as a percentage compared to the entire measurement range (Full Scale: F.S.), such as 1% F.S..
- 4 **Hysteresis:** Hysteresis is the maximum difference between the rising curve and the falling curve when the input signal is varied from 0% to 100% and 100% to 0%, indicated by the percentage relative to the full scale.
- 5 **Repeatability:** Repeatability is the maximum deviation of control pressure measured when the same input signal is applied repeatedly in a short time and under the same operating conditions. Repeatability is indicated by the percentage relative to the full scale.
- 6 **Sensitivity:** Sensitivity is the minimum value of the input signal that changes the control pressure, indicated by the percentage relative to the full scale.
- 7 **Temperature characteristics:** The difference of the control pressure level made by 1°C difference of the ambient temperature (with reference temperature 25°C) is converted by calculation.

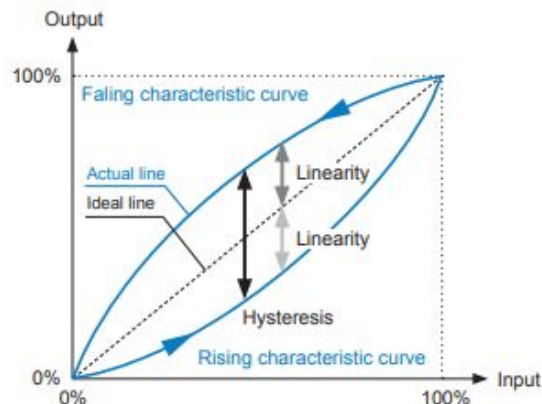



Feature

- Stepless control of air pressure proportional to an electrical signal.
- Simplify complex pipeline for controlling different pressure.
- Achieve high precision pressure control with microcomputer PID.
- Maximum flow rate 1500 L/min (Supply pressure 1.0 MPa, Set pressure 0.6 MPa).
- Comply with IP65 and CE certification.

Symbol

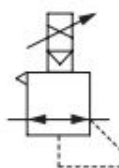

Specification

Pressure range		1K	5K	9K
Bore No.			8A, 10A	
Port size			1/4, 3/8	
Medium		Air		
Proof pressure		0.3 MPa	1.5 MPa	
Ambient temperature		+5~+50°C (No condensation)		
Min. supply pressure		Set pressure +0.1 MPa		
Max. supply pressure		0.2 MPa	0.7 MPa	1 MPa
Setting pressure range (*1)		0.005~0.1 MPa	0.005~0.5 MPa	0.009~0.9 MPa
Power consumption	Voltage	DC24V±10%		
	Current	DC24V: 0.1A or less		
Signal input	Current type	DC4~20 mA		
	Voltage type	DC0~5V, DC0~10V		
	Preset input (*2)	4 points		
Input impedance	Current type	≤ 430Ω		
	Voltage type	Approx. ≤ 3kΩ		
	Preset type	Approx. ≤ 100kΩ		
Signal output (Monitor output)	Analog output	Current type DC4~20mA (Load impedance 600Ω or less)		
	Switch output	Voltage type DC1~5V (Load impedance 500Ω or above)		
		NPN,PNP: Max. 24V, 160mA		
Linearity		Within ±1% (F.S.)		
Hysteresis		Within 0.5% (F.S.)		
Repeatability		Within ±0.5% (F.S.)		
Sensitivity		Within 0.2% (F.S.)		
Temperature characteristics		Within ±0.2% (F.S.)°C		
Output pressure display (*3)	Precision	±2% F.S. ±1 digit		
	Min. unit	MPa:0.001, kgf/cm ² :0.01, bar:0.01, psi:0.1, kPa:1		
Enclosure		Equivalent to IP65		
Weight		Main: 360 g; Bracket: Approx. 86g(B1) , 80g(B2); Cable connector: Approx. 55g(1m) , 130g(3m)		

*1. Minimum setting pressure is equal to 1% F.S..

*2. For safety reasons, it is recommended that one of the preset pressures be set to 0 MPa.

*3. Linearity setting and preset pressure setting value both are set by the minimum unit of the output pressure display.

*4. The above characteristics are confined to no flow in the pipeline. When air is consumed on the output side, pressure may become unstable.

*5. The above characteristics apply for a control pressure of 10% to 90% when power voltage is 24 VDC, ambient temperature is 25±3°C, no-loading and working pressure is maximum control pressure.

1K

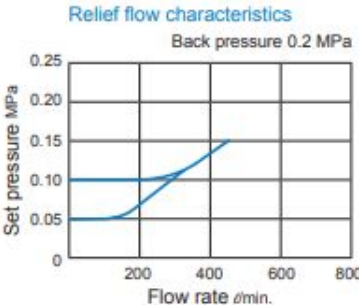
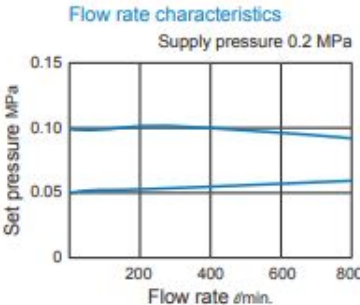
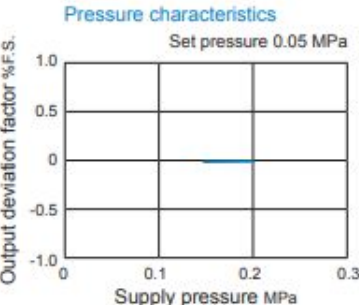
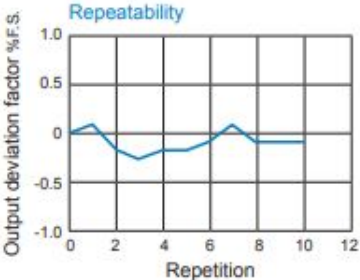
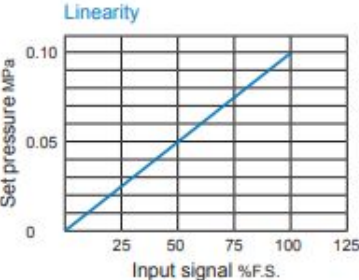

5K

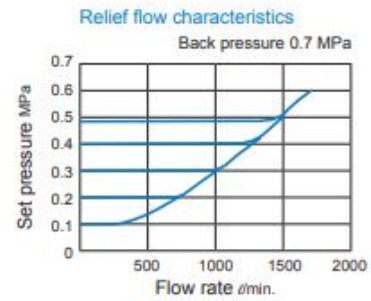
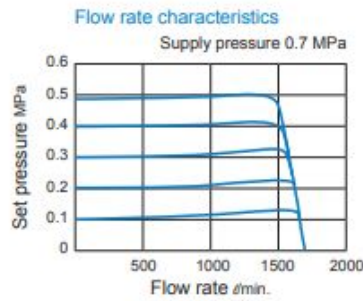
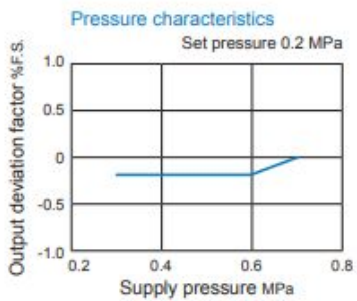
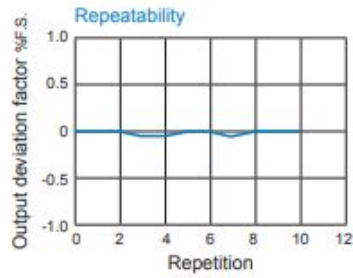
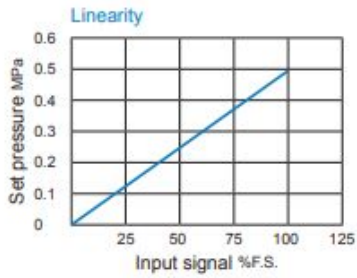

9K

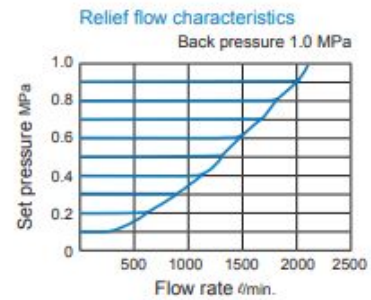
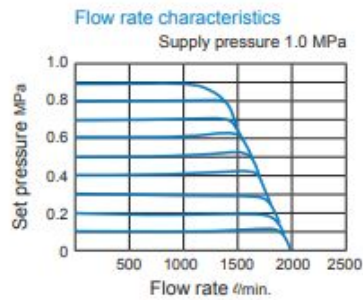
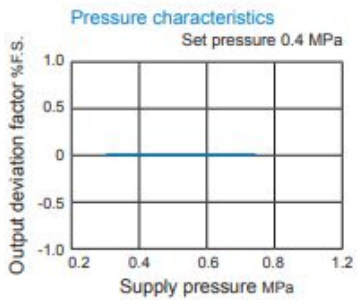
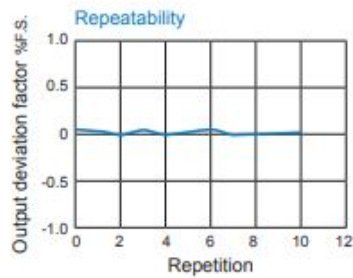
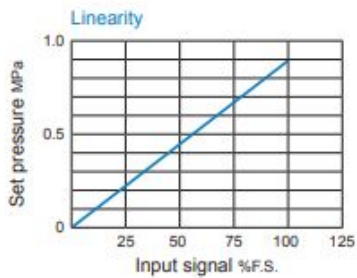

L type bracket

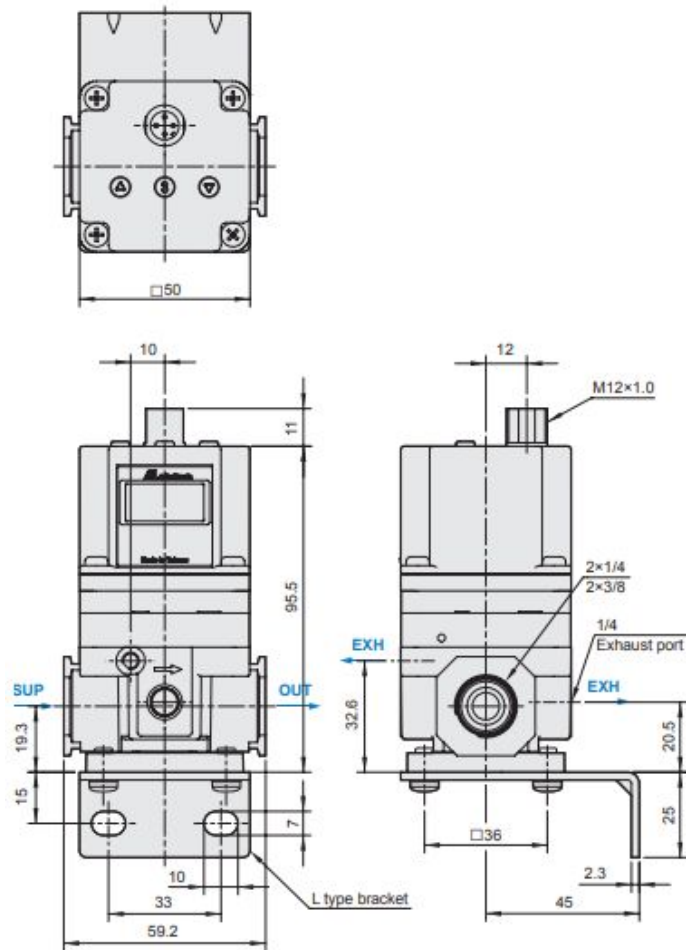

Flat type bracket

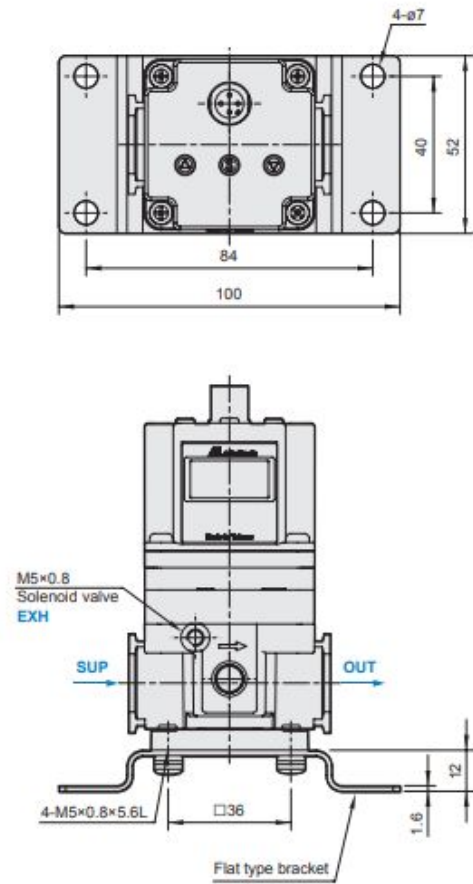

Straight cable connector

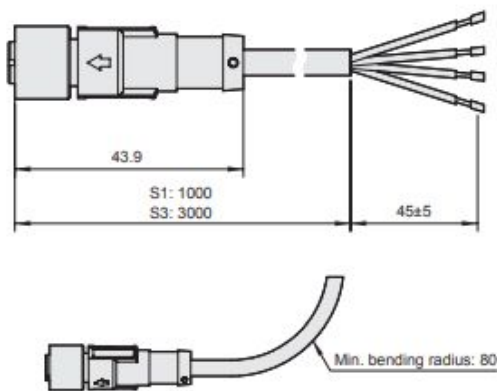

Angle cable connector

